

# KOMATSU®

## PC210LL-10 Tier 4 Interim Engine

PC210LL

### NET HORSEPOWER

158 HP @ 2000rpm  
118 kW @ 2000rpm

### OPERATING WEIGHT

Road Builder	65,118 lb	29,537 kg
Log Loader	68,577 lb	31,106 kg



PHOTOS MAY INCLUDE OPTIONAL EQUIPMENT

1. HD reinforced front idler
2. HD straddle mounted carrier roller
3. Ski-type roller guards
4. PC240 class final drives with 7.5" pitch track
5. PC240 class swing system
6. HD 9mm full under cover guards
7. Full length grip strut walkways
8. HD 6mm rear compartment doors
9. Engine heat shields
10. Rear view camera
11. Komatsu HD Excavator boom & arm or Allied forestry booms
12. Komatsu ROPS/OPS/FOPS/TOPS/FOG/WCB/Oregon OSHA certified forestry cab with Komatsu excavator interior
13. 7" fixed cab riser or 48" hydraulic tilting cab riser
14. Komatsu designed cylinders and cylinder components
15. High and standard carbody with 2-hinged HD swivel guard and front/rear pull hooks
16. Reinforced revolving frame
17. High pressure pump outlet screens
18. Optional auxiliary fuel tank



## KOMTRAX®

Komtrax equipped machines can send location, SMR and operation maps to a secure website utilizing wireless technology. Machines also relay error codes, cautions, maintenance items, fuel levels, and much more.



## NET HORSEPOWER

158 HP @ 2000rpm  
118 kW @2000rpm

## OPERATING WEIGHT

Road Builder	65,118 lb	29,537 kg
Log Loader	68,577 lb	31,106 kg



## VERSATILITY, POWER & LOWER FUEL CONSUMPTION

**High and Standard Undercarriage Design** provides a rugged platform to handle the most demanding Processor, Log Loader and Road Builder forestry applications.

**7% more HP with new engine and hydraulic pump control technology** improves operational efficiency and lowers fuel consumption by up to 10% (vs. prior PC200LL-8 model).

**A powerful Komatsu SAA6D107E-2 engine** provides a net output of 118 kW **158 HP**. This engine is EPA Tier 4 Interim and EU Stage 3B emissions certified.

**Komatsu Variable Geometry Turbocharger (KVGIT)** uses a hydraulic actuator to provide optimum air flow under all speed and load conditions.

**Komatsu Diesel Particulate Filter (KDPF)** captures 90% of particulate matter. Special forestry regeneration logic prompts the operator to select a location for initiating a manual stationary regeneration.

**Komatsu ROPS/OPS/FOPS/TOPS/FOG/WCB/ Oregon OSHA certified forestry cab**

- High back, heated, and air suspension operator seat
- Enhanced working environment

**Komatsu HD excavator boom and arm** for Processor and Road Builder applications, or forestry booms for Log Loader applications.

**Robust undercarriage** is designed using larger size class components for increased performance, reliability and component longevity.

**Large maximum drawbar pull** provides excellent maneuverability and shovel logging performance.

**Large LCD color monitor panel:**

- 7" high resolution screen
- Provides "Eco-Guidance" for fuel efficient operation
- Enhanced attachment control

**Rearview monitoring system (standard)**

**Enhanced working modes** are designed to match engine speed, pump delivery, and system pressure to the application.

**Two boom mode settings** provide power mode for maximum digging force or smooth mode for fine grading operations.

**Equipment Management Monitoring System (EMMS)** continuously monitors machine operation and vital systems to identify machine issues and assist with troubleshooting.

**Komatsu's Closed Center Load Sensing (CLSS)** hydraulic system provides quick response and smooth operation to maximize productivity.



**Grip strut walkways and handrails** located on the machine upper structure provide a more convenient work area along both sides of the machine for maintenance and service.

**Battery disconnect switch** allows a technician to disconnect the power supply before servicing the machine.

**Heavy duty forestry guarding** package for rugged logging applications.

**Komatsu designed and manufactured components** including: excavator boom & arm, forestry cab, undercarriage, engine, hydraulic pumps, hydraulic motors, control valves and hydraulic cylinders.



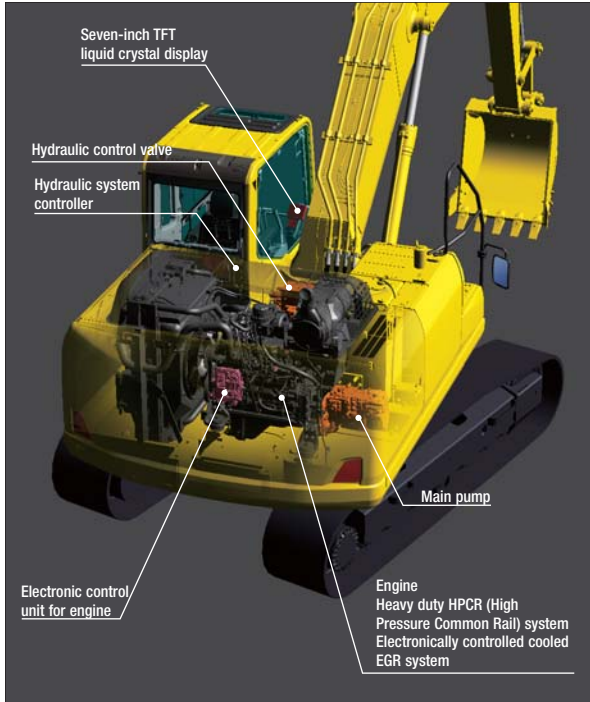

### Advanced Electronic Control System

The engine control system has been upgraded to effectively manage the air flow rate, EGR gas flow rate, fuel injection parameters, and aftertreatment functions. The new control system also provides enhanced diagnostic capabilities.

### Environmentally-Friendly Engine

The Komatsu SAA6D107E-2 engine is EPA Tier 4 Interim and EU Stage 3B emissions certified and provides exceptional performance while reducing fuel consumption. Based on Komatsu proprietary technologies developed over many years, this new diesel engine reduces exhaust gas particulate matter (PM) by more than 90% and nitrogen oxides (NOx) by more than 45% when compared to Tier 3 levels.

Through the in-house development and production of engines, electronics, and hydraulic components, Komatsu has achieved great advancements in technology, providing high levels of performance and efficiency in virtually all applications.

### Low Operational Noise

The PC210LL-10 provides low noise operation using a low noise engine and methods that reduce noise at the source such as sound absorbing materials.

### Komatsu Diesel Particulate Filter (KDPF) Special Forestry Regeneration Logic

Komatsu has developed a high efficiency diesel particulate filter that captures more than 90% of particulate matter. When required, the engine controller displays a message that a manual stationary regeneration is needed so the operator can select a time and location for regeneration. A special oxidation catalyst with a fuel injection system is used to oxidize and remove particulate matter while the machine is running so the regeneration process will not interfere with daily operation.

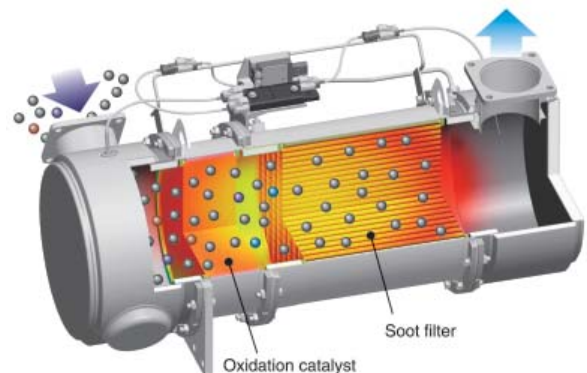

## Komatsu Variable Geometry Turbocharger (KVG T)

Using Komatsu proprietary technology, a newly designed variable geometry turbocharger with a hydraulic actuator is used to manage and deliver optimum air flow to the combustion chamber under all speed and load conditions. The robust hydraulic actuator provides power and precision, resulting in cleaner exhaust gas and improved fuel economy while maintaining performance.

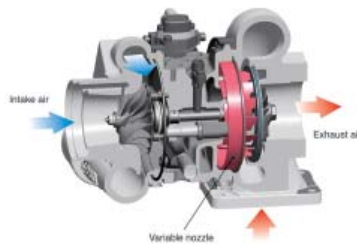

## Komatsu Closed Crankcase Ventilation (KCCV)

Crankcase emissions (blow-by gas) are passed through a Komatsu CCV filter. The KCCV filter traps oil mist which is returned back to the crankcase while the gas, which is almost oil mist free, is fed back to the air intake.



## Redesigned Combustion Chamber

The combustion chamber has a new shape designed to improve combustion and further reduce NOx, PM, fuel consumption, and noise levels.

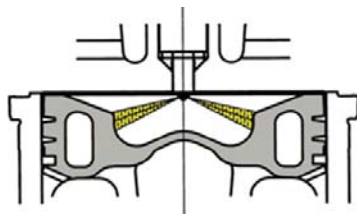

## Cooled Exhaust Gas Recirculation (EGR)

Cooled EGR, a technology that has been well proven in Komatsu Tier 3 engines, reduces NOx emissions to meet Tier 4 levels. The hydraulically actuated EGR system has increased capacity and uses larger and more robust components to ensure reliability for demanding work conditions.

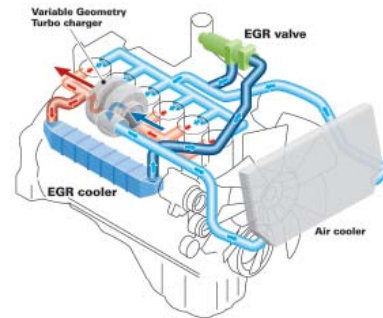

## Heavy Duty High Pressure Common Rail (HPCR) Fuel Injection System

The heavy duty HPCR system is electronically controlled to deliver a precise quantity of pressurized fuel into the combustion chamber using multiple injection events to achieve complete fuel burn and reduce exhaust gas emissions. Fuel injector reliability has been improved by using ultra-hard wear resistant materials.

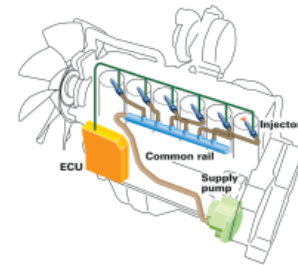

## Large Digging Force - Road Builder

The PC210LL-10 is equipped with the Power Max system. This function temporarily increases digging force for 8.5 seconds of operation.

### Maximum arm crowd force (ISO):

101 kN (10.3 t) ➔ **108 kN (11.0 t)** **7 % UP**  
(with Power Max.)

### Maximum bucket digging force (ISO):

138 kN (14.1 t) ➔ **149 kN (15.2 t)** **8 % UP**  
(with Power Max.)

\* Measured with Power Max function, 2925 mm arm and ISO rating



## Efficient Hydraulic System

The PC210LL-10 uses a Closed Center Load Sensing (CLSS) hydraulic system that improves fuel efficiency and provides quick response to the operator's demands.

The PC210LL-10 also introduces new technology to enhance the engine and hydraulic pump control. This total control system matches the engine and hydraulics at the most efficient point under any load condition. There have also been improvements in the main valve and hydraulic circuit to reduce hydraulic loss, resulting in higher efficiency and lower fuel consumption.

**Reduced Up To 10% Fuel consumption**

vs PC200L-8  
Based on typical work pattern collected via KOMTRAX

## Rugged Undercarriage Design

The PC210LL-10 uses a rugged high and standard undercarriage designed specifically for demanding Processor, Log Loader and Road Builder forestry applications.

## Large Maximum Drawbar Pull

Provides excellent maneuverability and shovel logging performance.

**Maximum Drawbar Pull 202 kN, 20570 kgf, 45,349 lb**

## Large Displacement High Efficiency Pump

Pump displacement has been increased, providing increased flow output as well as operation at the most efficient engine speed.

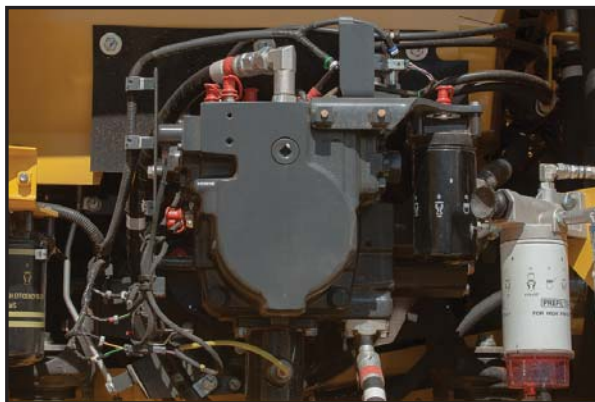

## Working Mode Selection

The PC210LL-10 is equipped with six working modes (P, E, L, B, ATT/P and ATT/E). Each mode is designed to match engine speed, pump flow, and system pressure to the application. The PC210LL-10 features a new mode (ATT/E) which allows operators to run attachments while in Economy mode.

Working Mode	Application	Advantage
<b>P</b>	Power mode	<ul style="list-style-type: none"> <li>•Maximum production/power</li> <li>•Fast cycle times</li> </ul>
<b>E</b>	Economy mode	<ul style="list-style-type: none"> <li>•Good cycle times</li> <li>•Better fuel economy</li> </ul>
<b>L</b>	Lifting mode	<ul style="list-style-type: none"> <li>•Increases hydraulic pressure</li> </ul>
<b>B</b>	Breaker mode	<ul style="list-style-type: none"> <li>•Optimum engine rpm, hydraulic flow</li> </ul>
<b>ATT/P</b>	Attachment Power mode	<ul style="list-style-type: none"> <li>•Optimum engine rpm, hydraulic flow, 2-way</li> <li>•Power mode</li> </ul>
<b>ATT/E</b>	Attachment Economy mode	<ul style="list-style-type: none"> <li>•Optimum engine rpm, hydraulic flow, 2-way</li> <li>•Economy mode</li> </ul>

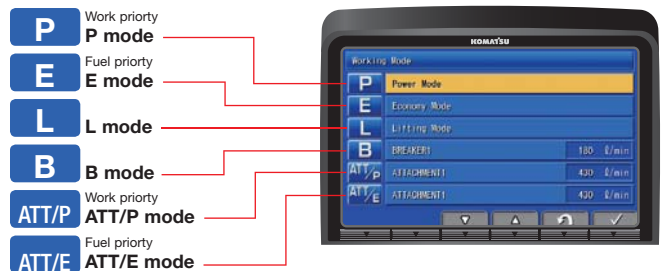

## Lifting Mode

When the lifting mode is selected, the lift capacity is increased 7% by raising the hydraulic pressure.

## Eco-Gauge Assists with Energy Saving Operations

The Eco-gauge and new fuel consumption gauge are viewed on the right side of the color monitor and assist the operator in maintaining lower fuel consumption and more environment friendly operation.

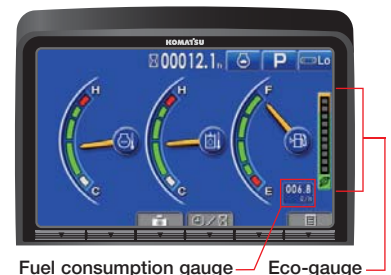

Fuel consumption gauge Eco-gauge

## RELIABILITY FEATURES

### High Rigidity Work Equipment

Komatsu excavator booms and arms are constructed with thick plates of high tensile strength steel. In addition, these structures are designed with large cross-sectional areas and large one piece castings in the boom foot, the boom tip, and the arm tip. The result is work equipment that exhibits long term durability and high resistance to bending and torsional stress.

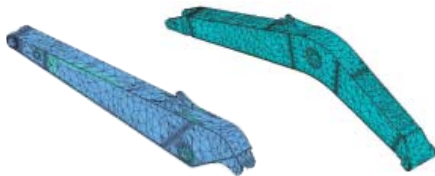

### High Efficiency Fuel Filter with a Fuel Pre-filter (with Water Separator)

A new high efficiency dual element fuel filter improves fuel system reliability. A fuel pre-filter removes water and contaminants in the fuel to increase reliability. For convenience, the fuel pre-filter has a built in priming pump.



Fuel filter      Fuel pre-filter (with water separator)

### Durable Frame Structure

The revolving frame, center frame, and undercarriage are designed using the most advanced three dimensional CAD and FEM analysis technology.

### Highly Reliable Electronic Devices

Exclusively designed electronic devices have passed severe testing.

- Controllers      • Sensors
- Connectors      • Heat Resistant Wiring

### Protective Forest Debris Screens

Engine hood, side access door and exhaust outlet cover screens provide added engine protection.



### DT-type Connectors

Sealed DT-type connectors provide high reliability, water resistance, and dust resistance

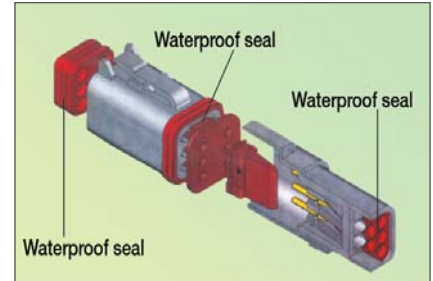

### Grease Sealed Track

The PC210LL-10 uses grease sealed tracks for extended undercarriage life.

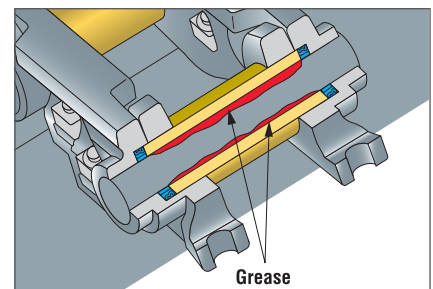

### Metal Guard Rings

The PC210LL-10 uses metal guard rings to protect all of the hydraulic cylinders and improve long term reliability.

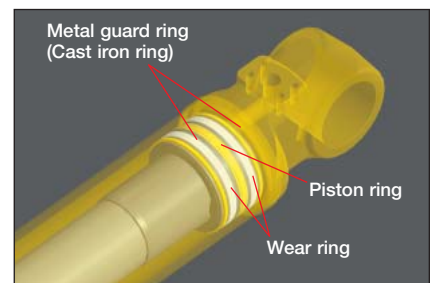

### O-Ring Face Seals

Flat face-to-face O-ring seals are used to securely seal hydraulic hose connections.



### Robust Forestry Undercarriage

The undercarriage is designed using larger size excavator components for improved reliability and long component life.



# WORKING ENVIRONMENT

## KOMATSU FORESTRY CAB FEATURES & BENEFITS



### New Komatsu ROPS/OPS/FOPS/TOPS/FOG/WCB/Oregon OSHA Certified Forestry Cab

The newly designed wide spacious cab features a high back, fully adjustable seat with a reclining backrest. The console and seat have an integrated design so that they move together and provide additional comfort for the operator.

The new higher capacity operator seat has been enhanced to provide more comfort.

- Heated
- Air Suspension
- Integrated Seat
- Console Mounted Arm Rests
- The cab is available with a 7" fixed riser or 48" hydraulic tilt cab riser.



### Low Cab Noise

The new cab design is highly rigid and has excellent sound absorption ability. By improving noise source reduction and by using a low noise engine, hydraulic equipment, and air conditioner, this machine is able to generate low noise levels similar to that of a modern automobile.

### Automatic Air Conditioner & Heater

The automatic air conditioner & heater allows the operator to easily and precisely set the cab atmosphere using the large LCD color monitor panel. The bi-level control function improves air flow and keeps the inside of the cab comfortable throughout the year.

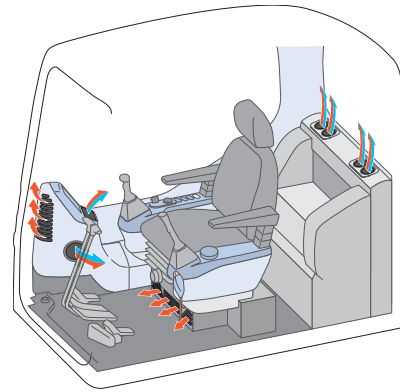

### Pressurized Cab

The air conditioner, air filter, and a higher internal cab air pressure minimize the amount of external dust that enters the cab.

### Low Vibration with Viscous Cab Floor Mounts

The PC210LL-10 uses viscous mounts for the seat platform that incorporate a longer stroke and the addition of a spring. The cab damper mounting combined with a high rigidity deck reduces vibration at the operator's seat.

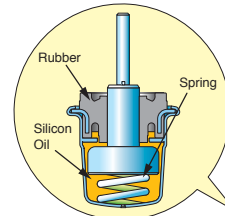

### Auxiliary Input (MP3 Jack)

By connecting an auxiliary device such as an MP3 player or satellite radio receiver to the auxiliary input, the operator can hear the sound through the speakers installed in the cab.







## Large 7" High Resolution LCD Monitor Panel

A new large, user-friendly, high resolution LCD color monitor enables accurate and smooth work. Screen visibility and resolution are further improved compared to the previous LCD monitor panel. The switches and function keys are easy to operate and provide simple navigation through the monitor screens.

Data is displayed in 25 languages to support operators around the world.

### Indicators

- |                                  |                                   |
|----------------------------------|-----------------------------------|
| 1 Auto-decelerator               | 5 Hydraulic oil temperature gauge |
| 2 Working mode                   | 6 Fuel gauge                      |
| 3 Travel speed                   | 7 Eco-gauge                       |
| 4 Engine water temperature gauge | 8 Fuel consumption gauge          |
|                                  | 9 Function switches menu          |

### Basic operation switches

- |                         |                     |
|-------------------------|---------------------|
| 1 Auto-decelerator      | 4 Buzzer cancel     |
| 2 Working mode selector | 5 Wiper             |
| 3 Traveling selector    | 6 Windshield washer |

## Operational "ECO" Guidance

The monitor panel provides operational advice to the operator to help improve machine efficiency and lower fuel consumption. The operator can access the ECO guidance menu to check the Operation Records, Eco Guidance Records, and Average Fuel Consumption Logs.



ECO Guidance



ECO Guidance menu



ECO Guidance Records



Operation Records



Average Fuel Consumption Logs

## Improved Attachment Control

The PC210LL-10 is capable of storing up to ten different attachments in the new monitor panel. The name of each attachment can be changed for better tool management. Hydraulic flow rates can be easily adjusted for one-way and two-way flow attachments.



Attachment Setting Screen



Attachment Flow Screen

## KDPF Condition Monitor

A soot level indicator is displayed to show how much soot is trapped in the KDPF.

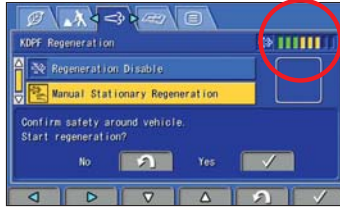

## Special Forestry KDPF Regeneration

When the machine requires KDPF regeneration, a manual stationary regeneration icon appears. Manual stationary regeneration allows the operator to select a time and location of his choosing to initiate the regeneration process.



## Easier Engine Access

Engine maintenance is made easier with a new platform.



## Sloped Track Frame

Reduces dirt and sand accumulation while allowing easier mud removal.



## Battery Disconnect Switch

A standard battery disconnect switch allows a technician to disconnect the power supply and lock out before servicing the machine.



## Long Life Oils and Filters

High performance filters are used in the hydraulic circuit and engine. By increasing the oil and filter replacement intervals, maintenance costs can be significantly reduced.



Hydraulic oil filter  
(Eco-white element)

<b>Engine oil &amp; Engine oil filter</b>	<b>every 500 hours</b>
<b>Hydraulic oil</b>	<b>every 5000 hours</b>
<b>Hydraulic oil filter</b>	<b>every 1000 hours</b>

## Engine Debris Screens

Engine debris screens are easily removed and cleaned (without the need for tools).



## Extended Work Equipment Greasing Intervals

Special hard material is used for the work equipment bushings to lengthen the greasing intervals. All work equipment bushing lubrication intervals, except the arm tip and bucket linkage, are 500 hours, reducing maintenance costs.

## Equipment Management Monitoring System (EMMS)

The PC210LL-10 features an advanced diagnostic system that continuously monitors the machine's vital systems. EMMS tracks maintenance items, provides advanced troubleshooting tools, reduces diagnostic times, and displays error codes.

Through continuous monitoring, the EMMS helps identify potential issues and allows the operator to concentrate on the work at hand.

## Equipped with Eco-drain Valve

Minimizes ground contamination due to oil leakage when replacing the engine oil.





## Advanced Monitoring System

The monitor provides advanced monitoring diagnostics to assist with troubleshooting and reduce costly downtime.



## Abnormalities Display with Code

When an abnormality occurs an error code is displayed on the monitor. When an important code is displayed, a caution lamp blinks and a warning buzzer sounds to alert the operator to take action.



## Maintenance Tracking

When the machine approaches or exceeds the oil and filter replacement interval, the monitor panel will display lights to inform the operator.



The monitor also stores a record of abnormalities for more effective troubleshooting.





### Thermal Protective Covers

Thermal protective covers for variable geometry turbocharger (KVTG) and diesel particulate filter (KDPF).



### Handrails

Handrails have been added on the upper structure of the machine. This provides additional convenience during engine service.



### Fan Guards

Fan guards are placed around parts of the engine and fan drive.



### Cab Working Lights

Forestry cab work light package includes: (4) cab front top, (2) cab rear top, (1) cab left side, (1) front of optional 48" cab riser.



### Rear-view Monitoring System (standard)

On the large LCD color monitor the operator can view the image from one camera that will display areas directly behind the machine.



Rear view image on monitor

### Seat Belt Caution Indicator

A warning indicator on the monitor appears when the seat belt is not engaged.



### Lock Lever

When the lock lever is placed in the lock position, all hydraulic controls (travel, swing, boom, arm, and bucket) are inoperable.



### Secondary Engine Shutdown Switch

A new secondary switch has been added to shutdown the engine.



### Slip Resistant Plates

Durable slip resistant plates maintain excellent foot traction.



### Tilting Cab Riser

Optional 48" riser has a hydraulic cab tilt feature to reduce transport height. Operates with convenient remote control from ground level.



### Compartment Covers

Rear compartment doors/covers are more than 3 times thicker than on PC210 excavators. Doors feature stronger hinges.



## KOMTRAX EQUIPMENT WORKING ENVIRONMENT MONITORING

GET THE WHOLE STORY WITH  
**KOMTRAX**<sup>®</sup>

### ✓ WHAT

KOMTRAX is Komatsu's remote equipment monitoring and management system

- KOMTRAX **continuously monitors and records** machine health and operational data
- Information such as fuel consumption, utilization, and a detailed history **aids in making repair or replacement decisions**

### ✓ WHO

- KOMTRAX is **standard** equipment on all Komatsu Log Loader Forestry products

### ✓ WHEN

- Know when your machines are **running or idling** and make decisions that can improve your fleet utilization
- Detailed movement records ensure you know when and where your equipment is moved
- Up to date records allow you to **know when maintenance was done** and help you plan for future maintenance needs

### ✓ WHERE

- KOMTRAX data **can be accessed virtually anywhere** through your computer, the web or your smart phone
- Automatic alerts keep fleet managers up to date on the latest machine notifications

### ✓ WHY

- Knowledge is power - **make informed decisions** to manage your fleet better
- Knowing your idle time and fuel consumption can help maximize your machine efficiency
- **Take control of your equipment** - any time, anywhere

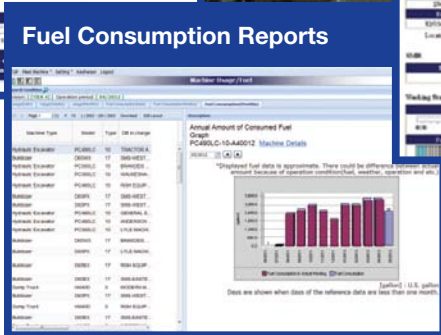
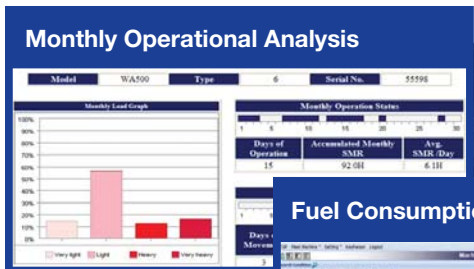

For construction and compact equipment.



For production and mining class machines.



# KOMATSU PARTS & SERVICE SUPPORT



## Komatsu CARE – Complimentary Scheduled Maintenance

- PM services for the earlier of 3 years / 2000 hours
- Performed by factory certified technicians
- Komatsu Genuine parts and fluids
- Significantly lowers your cost of ownership while maintaining high uptime and reliability
- Increases resale value and provides detailed maintenance records
- Extended PM services can be purchased beyond the complimentary period to provide additional peace of mind and maximize uptime



## Komatsu Parts Support

- 24/7/365 to fulfill your parts needs
- 9 parts Distribution Centers strategically located across the U.S. and Canada
- Distributor network of more than 300 locations across U.S. and Canada to serve you
- Online part ordering through Komatsu eParts
- Remanufactured components with same-as-new warranties at a significant cost reduction

## Komatsu CARE – Extended Coverage

- Extended Coverage can provide peace of mind by protecting customers from unplanned expenses that effect cash flow
- Purchasing extended coverage locks-in the cost of covered parts and labor for the coverage period and helps turn these into fixed costs



## Komatsu Oil and Wear Analysis (KOWA)

- KOWA detects fuel dilution, coolant leaks, and measures wear metals
- Proactively maintain your equipment
- Maximize availability and performance
- Can identify potential problems before they lead to major repairs
- Reduce life cycle cost by extending component life



## SPECIFICATIONS



### ENGINE

Model..... Komatsu SAA6D107E-2\*  
 Type ..... Water-cooled, 4-cycle, direct injection  
 Aspiration..... Turbocharged, aftercooled, cooled EGR  
 Number of cylinders..... 6  
 Bore / Stroke..... 107 mm **4.21"** / 124 mm **4.88"**  
 Piston displacement..... 6.69 ltr **408 in<sup>3</sup>**  
 Horsepower: SAE J1995.....Gross 123 kW **165 HP**  
 ISO 9249 / SAE J1349 .....Net 118 kW **158 HP**  
 Rated rpm..... 2000  
 Fan drive method for radiator cooling..... Mechanical  
 Governor..... All-speed control, electronic  
 \*EPA Tier 4 Interim and EU stage 3B emissions certified



### HYDRAULICS

Type.....HydrauMind (Hydraulic Mechanical Intelligence New Design) system, closed-center system with load sensing valves and pressure compensated valves  
 Number of selectable working modes ..... 6  
 Main pump (type) .....Variable displacement piston type  
 Pumps for.....Boom, arm, bucket, swing, and travel circuits  
 Maximum flow .....475 ltr/min **125.5 gal/min**  
 Supply for control circuit.....Self-reducing valve  
 Hydraulic motors:  
 Travel..... 2 x axial piston motors with parking brake  
 Swing ..... 1 x axial piston motor with swing holding brake  
 Relief valve setting:  
 Implement circuits . . . . .37.3 MPa 380 kg/cm<sup>2</sup> **5,400 psi**  
 Travel circuit . . . . .37.3 MPa 380 kg/cm<sup>2</sup> **5,400 psi**  
 Swing circuit . . . . .28.9 MPa 295 kg/cm<sup>2</sup> **4,190 psi**  
 Pilot circuit . . . . .3.2 MPa 33 kg/cm<sup>2</sup> **470 psi**  
 Service valve . . . . .24.5 MPa 250 kg/cm<sup>2</sup> **3556 psi**

Hydraulic cylinders: (Number of cylinders – bore x stroke x rod diameter)

#### Road Builder

Boom (2) 130 mm x 1334 mm x 90 mm  
**5.1" x 52.5" x 3.5"**  
 Arm (1) 135 mm x 1490 mm x 95 mm  
**5.3" x 58.7" x 3.7"**  
 Bucket (1) 115 mm x 1120 mm x 80 mm  
**4.5" x 44.1" x 3.2"**

Service valve maximum flow:

First valve . . . . .475 ltr **125 U.S. gal**  
 Second valve . . . . .237.5 ltr **63 U.S. gal**



### DRIVES AND BRAKES

Steering control..... Two levers with pedals  
 Drive method ..... Hydrostatic  
 Maximum drawbar pull .....202 kN 20570 kgf **45,349 lb**  
 Gradeability.....70%, 35°  
 Maximum travel speed: High..... 5.5 km/h **3.4 mph**  
 (Auto-Shift) Mid..... 4.1 km/h **2.5 mph**  
 (Auto-Shift) Low ..... 3.0 km/h **1.9 mph**  
 Service brake..... Hydraulic lock  
 Parking brake..... Mechanical disc brake



### SWING SYSTEM

Drive method ..... Hydrostatic  
 Swing reduction ..... Planetary gear  
 Swing circle lubrication ..... Grease-bathed  
 Service brake..... Hydraulic lock  
 Holding brake/Swing lock..... Mechanical disc brake  
 Swing speed ..... 10.6 rpm  
 Swing torque..... 8,065 kg•m **58,334 ft lbs**



### UNDERCARRIAGE

Center frame ..... X-frame  
 Track frame ..... Box-section  
 Seal of track ..... Sealed track  
 Track adjuster ..... Hydraulic  
 Number of shoes (each side) ..... 51  
 Number of carrier rollers (each side) ..... 2  
 Number of track rollers (each side) ..... 10



### COOLANT & LUBRICANT CAPACITY (REFILLING)

Fuel tank ..... 400 ltr **105.7 U.S. gal**  
 Coolant ..... 36 ltr **9.5 U.S. gal**  
 Engine..... 23.1 ltr **6.1 U.S. gal**  
 Final drive, each side..... 5.0 ltr **1.3 U.S. gal**  
 Swing drive ..... 7.2 ltr **1.9 U.S. gal**  
 Hydraulic tank..... 132 ltr **34.9 U.S. gal**  
 Hydraulic system..... 234 ltr **61.8 U.S. gal**



### OPERATING WEIGHT (APPROXIMATE)

#### Log Loader:

Includes: Forestry cab with 48" riser, high-standard track frame, 700 mm double grouser shoes, Allied 36' live heel logging boom, standard counterweight, right hand HD box guard, rated capacity of lubricants, coolant, full fuel tank, operator, and standard equipment.

#### Road Builder:

Includes: Forestry cab with 7" riser, high-standard track frame, 700mm double grouser shoes, 5700 mm (18'8") HD boom, 2925 mm (9'7") HD arm, 0.8m<sup>3</sup> (1.05 yd<sup>3</sup>) bucket, thumb on bucket, standard counterweight, right hand HD box guard, rated capacity of lubricants, coolant, full fuel tank; operator, and standard equipment.

Configuration	Operating Weight	Ground Pressure
Log Loader	31,106 kg <b>68,577 lb</b>	0.54 kg/cm <sup>2</sup> <b>7.68 psi</b>
Road Builder	29,537 kg <b>65,118 lb</b>	0.51 kg/cm <sup>2</sup> <b>7.25 psi</b>



## DIMENSIONS - LOG LOADER (All dimensions are from ground line except where noted)

	Live Heel	10,972 mm	36'
A	Overall length <b>(without</b> auxiliary fuel tank)	13,559 mm	44'6"
A	Overall length <b>(with</b> auxiliary fuel tank)	13,809 mm	45'4"
B	Length on ground (transport)	12,935 mm	42'6"
C	Overall height (to top of boom)*	2,786 mm	9'2"
D	Width of crawler (high and standard)	3,327 mm	10'11"
E1	Overall height (cab upright, w/48" riser)*	4,898 mm	16'1"
E2	Overall height (to top of cab tilted)*	3,379 mm	11'2"
F	Overall height (to top of handrail)*	3,445 mm	11'4"
G	Ground clearance, revolving frame	1,331 mm	4'4"
H	Ground clearance, minimum	714 mm	2'4"
I	Tail swing radius <b>(without</b> auxiliary fuel tank)	2,940 mm	9'8"
I	Tail swing radius <b>(with</b> auxiliary fuel tank)	3,178 mm	10'6"
J	Track length on ground	3,826 mm	12'7"
K	Track length	4,645 mm	15'3"
L	Track gauge	2,627 mm	8'8"
N	Shoe width	700 mm	2'4"
O	Grouser height, double	35 mm	1.4"
Q	Machine cab width <b>(without</b> revo steps)	3,315 mm	10'11"
Q	Machine cab width <b>(with</b> revo steps)	3,410 mm	11'3"
R	Swing center to rear end <b>(without</b> auxiliary fuel tank)	2,906 mm	9'7"
R	Swing center to rear end <b>(with</b> auxiliary fuel tank)	3,156 mm	10'5"

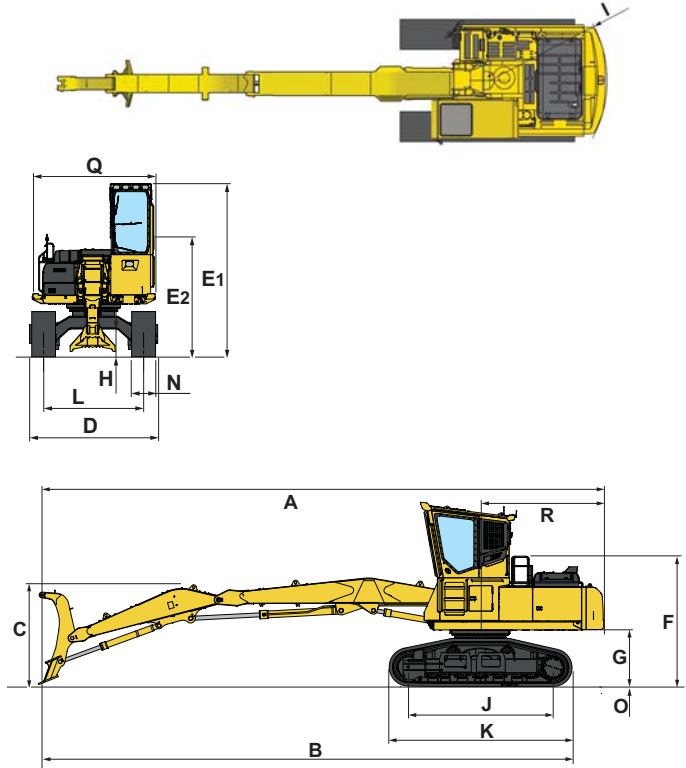

## DIMENSIONS - ROAD BUILDER (All dimensions are from ground line except where noted)

	Arm Length	2925 mm	9'7"
A	Overall length <b>(without</b> auxiliary fuel tank)	9,475 mm	31'2"
A	Overall length <b>(with</b> auxiliary fuel tank)	9,725 mm	31'11"
B	Length on ground (transport)	4,973 mm	16'4"
C	Overall height (to top of boom)*	3,060 mm	10'1"
D	Width of crawler (high and standard)	3,327 mm	10'11"
E	Overall height (to top of cab)*	3,926 mm	12'11"
F	Overall height (to top of handrail)*	3,445 mm	11'4"
G	Ground clearance, revolving frame	1,331 mm	4'4"
H	Ground clearance, minimum	714 mm	2'4"
I	Tail swing radius <b>(without</b> auxiliary fuel tank)	2,940 mm	9'8"
I	Tail swing radius <b>(with</b> auxiliary fuel tank)	3,178 mm	10'6"
J	Track length on ground	3,826 mm	12'7"
K	Track length	4,621 mm	15'2"
L	Track gauge (high and standard)	2,627 mm	8'8"
N	Shoe width	700 mm	2'4"
O	Grouser height, double	35 mm	1.4"
Q	Machine cab width <b>(without</b> revo steps)	3,315 mm	10'11"
Q	Machine cab width <b>(with</b> revo steps)	3,410 mm	11'3"
R	Swing center to rear end <b>(without</b> auxiliary fuel tank)	2,906 mm	9'7"
R	Swing center to rear end <b>(with</b> auxiliary fuel tank)	3,156 mm	10'5"

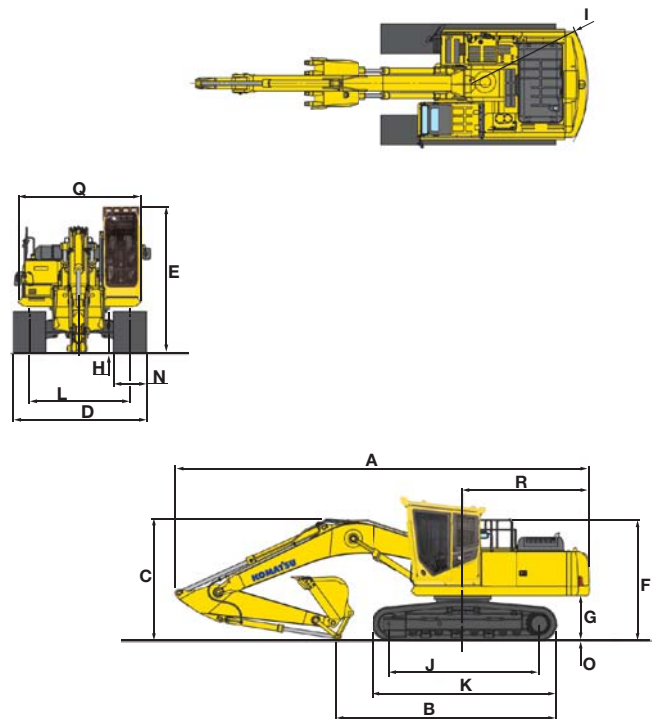

\* Including grouser height



## LOG LOADER WORKING RANGE

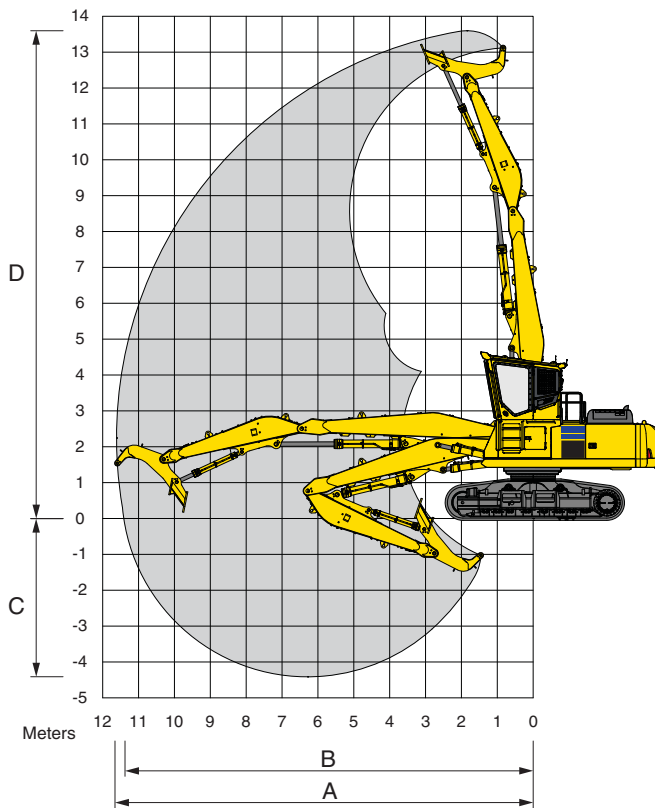

	Live Heel	10,972 mm	36'
<b>A</b>	Max reach	10,960 mm	35'11"
<b>B</b>	Max reach at ground level	10,629 mm	34'10"
<b>C</b>	Max below grade depth	2,946 mm	9'8"
<b>D</b>	Max above grade height	12,982 mm	42'7"



## ROAD BUILDER WORKING RANGE

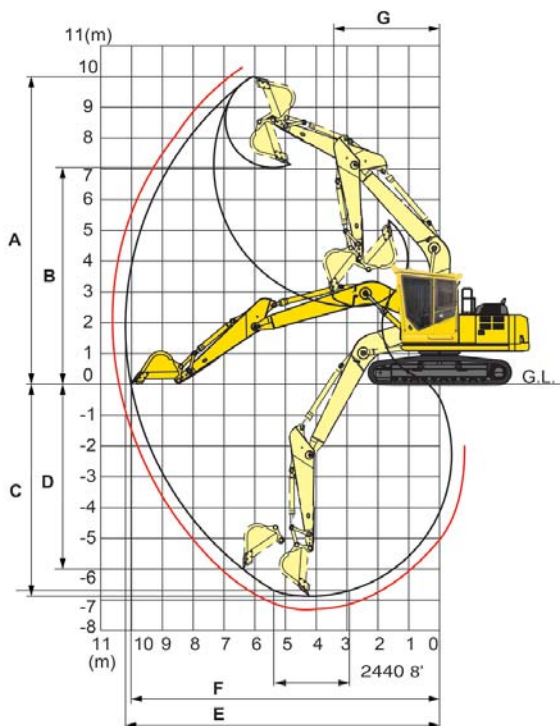

	Arm Length	2925 mm	9'7"
<b>A</b>	Max. digging height	10,348 mm	33'11"
<b>B</b>	Max. dumping height	7,465 mm	24'6"
<b>C</b>	Max. digging depth	6,210 mm	20'4"
<b>D</b>	Max. vertical wall digging depth	5,480 mm	18'
<b>E</b>	Max. digging reach	9,850 mm	32'4"
<b>F</b>	Max. digging reach at ground level	9,607 mm	31'6"
<b>G</b>	Min. swing radius	3,022 mm	9'11"
<b>H</b>	Min. dumping height	2,992 mm	9'10"
<b>SAE rating</b>	Bucket digging force at power max.	132 kN	29,762 lb
	Arm crowd force at power max.	103 kN	23,149 lb
<b>ISO rating</b>	Bucket digging force at power max.	149 kN	33,510 lb
	Arm crowd force at power max.	108 kN	24,250 lb



# LIFT CAPACITIES



## LIFTING CAPACITY WITH LIFTING MODE - ROAD BUILDER (WITHOUT AUXILIARY FUEL TANK)

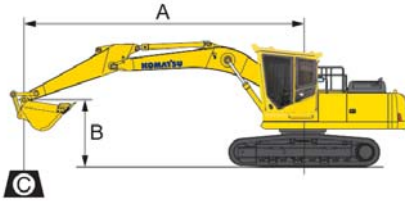

- A: Reach from swing center
- B: Bucket hook height
- C: Lifting capacity
- Cf: Rating over front
- Cs: Rating over side
- ⊗: Rating at maximum reach

- Conditions :
- Boom: 18'8" 5700 mm one piece
  - Bucket: 0.8 m<sup>3</sup>, 1.07 yd<sup>3</sup>
  - Lifting mode: On
  - Counterweight: Standard
  - Cab: Komatsu forestry with 7" riser

Arm: 2925 mm 9'7"

Shoes: 700 mm 28" - Double Grouser

Unit: kg lb

B	A 1.5 m 5'		3.01 m 10'		4.61 m 15'		6.11 m 20'		7.61 m 25'		Max Reach	⊗ MAX	
	Cf	Cs	Cf	Cs	Cf	Cs	Cf	Cs	Cf	Cs		Cf	Cs
7.6 m 25'							3,600	3,600			6.3	2,900	2,900
							* 8,000	* 8,000			21'	* 6,450	* 6,450
6.1 m 20'							5,250	5,250			7.4	2,750	2,750
							* 11,600	* 11,600			24'	* 6,100	* 6,100
4.6 m 15'					6,600	6,600	5,950	5,950	4,850	4,850	8.1	2,800	2,800
					* 14,650	* 14,650	* 13,200	* 13,200	* 10,650	* 10,650	27'	* 6,150	* 6,150
3.0 m 10'			13,650	13,650	9,250	9,250	7,150	6,850	6,250	4,800	8.5	2,900	2,900
			* 30,050	* 30,050	* 20,450	* 20,450	* 15,850	* 15,100	* 13,800	10,650	28'	* 6,500	* 6,500
1.5 m 5'					11,800	10,200	8,450	6,600	6,900	4,700	8.6	3,200	3,200
					* 26,000	* 22,500	* 18,650	* 14,550	* 15,200	10,400	28'	* 7,150	* 7,150
0 m 0'			5,500	5,500	13,100	9,850	9,350	6,400	6,900	4,600	8.4	3,750	3,750
			* 12,150	* 12,150	* 28,900	21,750	* 20,650	14,150	15,300	10,150	27'	* 8,250	* 8,250
-1.5 m -5'	5,300	5,300	9,600	9,600	13,300	9,700	9,700	6,300	6,850	4,550	7.9	4,650	4,350
	* 11,700	* 11,700	* 21,250	* 21,250	* 29,350	21,450	21,350	13,950	15,200	10,100	26'	* 10,250	9,650
-3.0 m -10'	9,950	9,950	16,200	16,200	12,800	9,800	9,400	6,300			7.0	6,550	5,200
	* 21,900	* 21,900	* 35,800	* 35,800	* 28,250	21,600	* 20,700	13,950			23'	* 14,550	11,500
-4.6 m -15'			15,650	15,650	11,000	10,000					5.6	8,400	7,300
			* 34,500	* 34,500	* 24,250	22,050					18'	* 18,550	16,150

\*Load is limited by hydraulic capacity rather than tipping. Ratings are based on SAE standard No. J1097. Rated loads do not exceed 87% of hydraulic lift capacity or 75% of tipping load.



## LIFTING CAPACITY WITH LIFTING MODE - ROAD BUILDER (WITH AUXILIARY FUEL TANK)

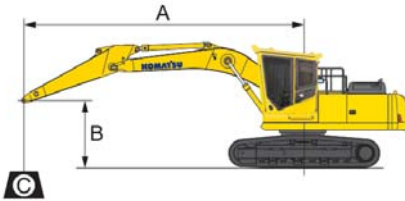

- A: Reach from swing center
- B: Bucket hook height
- C: Lifting capacity
- Cf: Rating over front
- Cs: Rating over side
- ⊗: Rating at maximum reach

- Conditions :
- Boom: 18'8" 5700 mm one piece
  - Bucket: None
  - Lifting mode: On
  - Counterweight: Standard
  - Cab: Komatsu forestry with 7" riser

Arm: 2925 mm 9'7"

Shoes: 700 mm 28" - Double Grouser

Unit: kg lb

B	A 1.5 m 5'		3.01 m 10'		4.61 m 15'		6.11 m 20'		7.61 m 25'		Max Reach	⊗ MAX	
	Cf	Cs	Cf	Cs	Cf	Cs	Cf	Cs	Cf	Cs		Cf	Cs
7.6 m 25'							3,600	3,600			6.3	2,900	2,900
							* 8,000	* 8,000			21'	* 6,450	* 6,450
6.1 m 20'							5,250	5,250			7.4	2,750	2,750
							* 11,600	* 11,600			24'	* 6,100	* 6,100
4.6 m 15'					6,600	6,600	5,950	5,950	4,850	4,850	8.1	2,800	2,800
					* 14,650	* 14,650	* 13,200	* 13,200	* 10,650	* 10,650	27'	* 6,150	* 6,150
3.0 m 10'			13,650	13,650	9,250	9,250	7,150	7,150	6,250	5,150	8.5	2,900	2,900
			* 30,050	* 30,050	* 20,450	* 20,450	* 15,850	* 15,850	* 13,800	11,450	28'	* 6,500	* 6,500
1.5 m 5'					11,800	10,900	8,450	7,050	6,900	5,050	8.6	3,200	3,200
					* 26,000	24,000	* 18,650	15,600	* 15,200	11,150	28'	* 7,150	* 7,150
0 m 0'			5,500	5,500	13,100	10,550	9,350	6,850	7,350	4,950	8.4	3,750	3,750
			* 12,250	* 12,150	* 28,900	23,250	* 20,650	15,150	16,200	10,950	27'	* 8,250	* 8,250
-1.5 m -5'	5,300	5,300	9,600	9,600	13,300	10,400	9,700	6,750	7,300	4,900	7.9	4,650	4,650
	* 11,700	* 11,700	* 21,250	* 21,250	* 29,350	23,000	* 21,400	14,950	16,100	10,850	26'	* 10,250	* 10,250
-3.0 m -10'	9,950	9,950	16,200	16,200	12,800	10,450	9,400	6,800			7.0	6,550	6,550
	* 21,900	* 21,900	* 35,800	* 35,800	* 28,250	23,100	* 20,700	15,000			23'	* 14,550	12,350
-4.6 m -15'			15,650	15,650	11,000	10,600					5.6	8,400	7,850
			* 34,500	* 34,500	* 24,250	23,400					18'	* 18,500	17,300

\*Load is limited by hydraulic capacity rather than tipping. Ratings are based on ISO standard No. 10567. Rated loads do not exceed 87% of hydraulic lift capacity or 75% of tipping load.



## LIFTING CAPACITY WITH LIFTING MODE - LOG LOADER (LESS GRAPPLE)

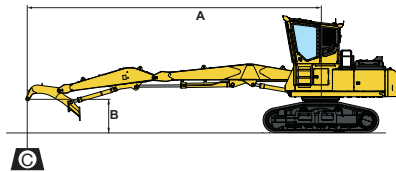

- A: Reach from swing center
- B: Grapple pin height
- C: Lifting capacity
- Cf: Rating over front
- Cs: Rating over side
- ⊗: Rating at maximum reach

- Conditions :
- Boom: 36' Live Heel
  - Grapple: None
  - Lifting mode: On
  - Counterweight: Standard
  - Cab: Komatsu forestry with 48" riser

Arm: 36' Live Heel

Shoes: 700 mm 28" - Double Grouser

Unit: kg lb

B	A	3.0 m 10'		4.6 m 15'		6.11 m 20'		7.61 m 25'		9.11 m 30'		10.71 m 35'	
		Cf	Cs	Cf	Cs	Cf	Cs	Cf	Cs	Cf	Cs	Cf	Cs
12.2 m 40'		17,522 38,630	17,522 38,360										
10.7 m 35'				10,738	10,738	9,442	7,410						
9.1 m 30'				9,833	9,833	8,704	7,859	7,747	5,278				
7.6 m 25'				9,799	9,799	8,620	7,935	7,735	5,453	5,734	3,884		
6.1 m 20'				8,769	8,769	9,025	7,837	7,864	5,433	5,810	3,955		
4.6 m 15'				9,642	9,642	7,595	7,792	7,792	5,319	5,783	3,930	4,228	3,003
3.0 m 10'				13,270	11,337	10,590	7,256	7,610	5,153	5,707	3,859	4,448	2,973
1.5 m 5'				14,762	10,523	10,480	6,910	7,419	4,977	5,618	3,775	4,435	2,962
0 m 0'				14,734	10,080	10,188	6,651	7,267	4,837	5,548	3,711		
-1.5 m -5'	5,260	5,260		12,930	9,915	10,041	6,520	7,188	4,765	5,522	3,686		
-3 m -10'	11,597	11,597		28,506	21,859	22,137	14,375	15,847	10,504	12,175	8,127		

\*Load is limited by hydraulic capacity rather than tipping. Ratings are based on ISO standard No. 10567. Rated loads do not exceed 87% of hydraulic lift capacity or 75% of tipping load.





**STANDARD EQUIPMENT**

- Alternator, 60 Ampere, 24 V
- AM/FM radio
- Automatic engine warm-up system
- Automatic air conditioner/heater
- Auxiliary input (3.5 mm jack)
- Batteries, large capacity (2 x 12V / 170 AH)
- Battery disconnect switch
- Boom and arm holding valves (for Excavator application)
- Converter, 24 V to 12 V
- Counterweight, 4720 kg **10,406 lb**
- KDPF with insulation wrap and heat shields
- Dry type air cleaner, double element
- Electric horn
- EMMS monitoring system
- Engine doors, HD (6mm)
- Engine, Komatsu SAA6D107E-2
- Engine overheat prevention system
- Extended work equipment grease interval
- Fan guard structure
- Forest debris screens, removable for cleaning
- Fuel system pre-cleaner 10 micron
- High back air suspension seat, with heat
- High-Standard forestry undercarriage
- High pressure in-line hydraulic filters
- Grip strut walkways
- Hydraulic track adjusters
- KOMTRAX® Level 4.0
- Large 177mm **7"** LCD color monitor, high resolution
- Lock lever
- Mirrors, (Rearview, LH and RH)
- Power maximizing system
- PPC hydraulic control system
- Pump/engine room partition cover
- Radiator and oil cooler dustproof net
- Rear reflectors
- Rearview monitoring system (1 camera)
- Revolving frame undercovers, HD (9mm)
- Seat belt, retractable, 76 mm **3"**
- Seat belt indicator
- Secondary engine shutoff switch
- Service valve
- Shoes, double grouser, 700 mm **28"**
- Swivel guard, HD
- Slip resistant foot plates
- Starter motor, 5.5 kW/24 V x 1
- Suction fan
- Thermal and fan guards
- Travel alarm
- Working Lights: 1 on right hand box
- Working mode selection system



**OPTIONAL EQUIPMENT**

- Arm holding valve
- Arms
  - 2925 mm **9' 7"** HD arm assembly with 1 actuator Piping
  - 2925 mm **9' 7"** HD arm assembly for Processor Head applications
- Booms
  - 5700 mm **18' 8"** HD excavator boom assembly with 1 actuator piping and 1 working light
  - 36' reach live heel forestry boom
  - 34' reach Butt-N-Top forestry boom (straight or cambered boom)
- Boom cylinders only
- Box guard, right hand, HD
- Cab arrangements
  - Forestry cab, Komatsu ROPS/OPS/FOPS/TOPS/FOG/WCB/Oregon OSHA Certified Forestry Cab with 177mm **7"** fixed riser and 7 working lights
  - Forestry cab, Forestry cab, Komatsu ROPS/OPS/FOPS/TOPS/FOG/WCB/Oregon OSHA Certified Forestry Cab with 1220 mm **48"** tilting riser and 8 working lights
  - Temporary shipping shell on "stilts"
- Flow controls and spool limiters
- Forestry grapple: 52" opening
- Fuel tank, auxiliary
- Soft swing system
- Straight travel system, single pedal



*Note: All comparisons and claims of improved performance made herein are made with respect to the prior Komatsu model unless otherwise specifically stated.*