

KOMATSU®

PC240LL-10

Tier 4 Interim Engine

PC240LL

NET HORSEPOWER

177 HP @ 2000rpm
132 kW @ 2000rpm

OPERATING WEIGHT

Log Loader	83,985 lb	38,095 kg
Road Builder	79,732 lb	36,165 kg



PHOTOS MAY INCLUDE OPTIONAL EQUIPMENT

1. HD reinforced front idler
2. HD straddle mounted carrier rollers
3. Ski-type roller guards
4. PC290 class final drives with 8.5" pitch track
5. PC360 class swing system
6. HD 9mm full under cover guards
7. Full length grip strut walkways
8. HD 6mm rear compartment doors
9. Engine heat shields
10. Rear view camera
11. Boom and arm cylinder guards
12. Komatsu 38' live heel boom

13. Komatsu Oregon OSHA ROPS/OPS/FOPS/TOPS/WCB certified forestry cab with Komatsu excavator interior
14. 48" hydraulic tilting or 7" fixed cab riser
15. Komatsu designed cylinders and cylinder components
16. Factory installed 52" or 58" forestry grapples
17. High and wide carbody with 2-piece hinged HD swivel guard and front/rear pull hooks
18. Reinforced revolving frame
19. High pressure pump outlet screens



KOMTRAX®

Komtrax equipped machines can send location, SMR and operation maps to a secure website utilizing wireless technology. Machines also relay error codes, cautions, maintenance items, fuel levels, and much more.

PC240LL-10

TIER 4 INTERIM ENGINE

NET HORSEPOWER

177 HP @ 2000rpm
132 kW @2000rpm

OPERATING WEIGHT

Log Loader	83,985 lb	38,095 kg
Road Builder	79,732 lb	36,165 kg



EXCEPTIONAL STABILITY & LOW FUEL CONSUMPTION

High and Wide Undercarriage

Design significantly increases overside lift capacity and provides exceptional lateral stability in applications that require long arms or heavy attachments.

New engine and hydraulic pump

control technology improves operational efficiency and lowers fuel consumption.

A powerful Komatsu SAA6D107E-2 engine provides a net output of 132 kW **177 HP**. This engine is EPA Tier 4 Interim and EU Stage 3B emissions certified.

Komatsu Variable Geometry Turbocharger (KVG) uses a hydraulic actuator to provide optimum air flow under all speed and load conditions.

Komatsu Diesel Particulate Filter (KDPF) Captures 90% of particulate matter. Special forestry regeneration logic prompts the operator to select a location for initiating a manual stationary regeneration.

Komatsu Oregon OSHA/ROPS/OPS/ FOPS/TOPS/WCB certified forestry cab

- High back, heated, and air suspension operator seat
- Enhanced working environment

Komatsu heavy duty live heel forestry boom

38' reach logging boom design with Komatsu cylinders and cylinder guards.

Robust undercarriage

is designed using larger size class components for increased performance, reliability and component longevity.

Large maximum drawbar pull

provides excellent maneuverability and shovel logging performance.

Large LCD color monitor panel:

- 7" high resolution screen
- Provides "Eco-Guidance" for fuel efficient operation
- Enhanced attachment control

Rearview monitoring system (standard)

Enhanced working modes

are designed to match engine speed, pump delivery, and system pressure to the application.

Two boom mode settings

provide power mode for maximum digging force or smooth mode for fine grading operations.

Equipment Management Monitoring System (EMMS)

continuously monitors machine operation and vital systems to identify machine issues and assist with troubleshooting.

Komatsu's Closed Center Load Sensing (CLSS)

hydraulic system provides quick response and smooth operation to maximize productivity.



Grip strut walkways and handrails

located on the machine upper structure provide a more convenient work area along both sides of the machine for maintenance and service.

Battery disconnect switch

allows a technician to disconnect the power supply before servicing the machine.

Heavy duty forestry guarding

package for rugged logging applications.

Komatsu designed and manufactured components

including: forestry boom, forestry cab, undercarriage, engine, hydraulic pumps, hydraulic motors, control valves and hydraulic cylinders.



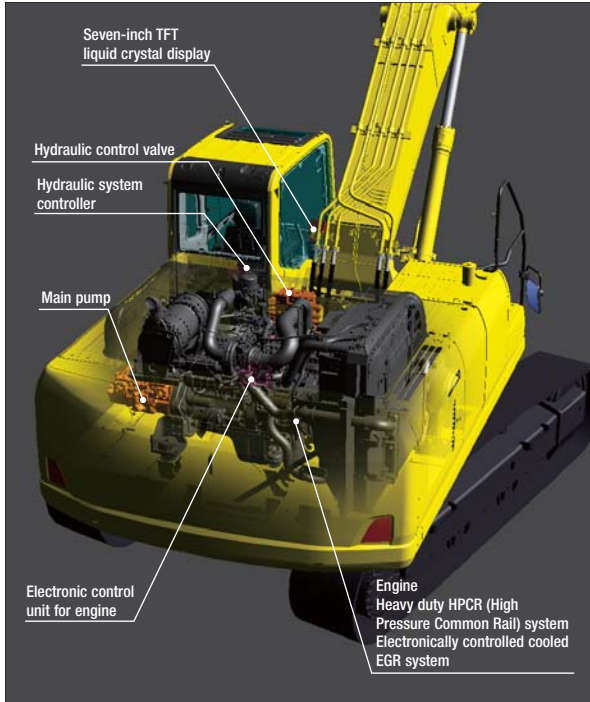

Advanced Electronic Control System

The engine control system has been upgraded to effectively manage the air flow rate, EGR gas flow rate, fuel injection parameters, and aftertreatment functions. The new control system also provides enhanced diagnostic capabilities.

Environmentally-Friendly Engine

The Komatsu SAA6D107E-2 engine is EPA Tier 4 Interim and EU Stage 3B emissions certified and provides exceptional performance while reducing fuel consumption. Based on Komatsu proprietary technologies developed over many years, this new diesel engine reduces exhaust gas particulate matter (PM) by more than 90% and nitrogen oxides (NOx) by more than 45% when compared to Tier 3 levels.

Through the in-house development and production of engines, electronics, and hydraulic components, Komatsu has achieved great advancements in technology, providing high levels of performance and efficiency in virtually all applications.

Low Operational Noise

The PC240LL-10 provides low noise operation using a low noise engine and methods that reduce noise at the source such as sound absorbing materials.

Komatsu Diesel Particulate Filter (KDPF)

Komatsu has developed a high efficiency diesel particulate filter that captures more than 90% of particulate matter. When required, the engine controller displays a message that a manual stationary regeneration is needed so the operator can select a time and location for regeneration. A special oxidation catalyst with a fuel injection system is used to oxidize and remove particulate matter while the machine is running so the regeneration process will not interfere with daily operation.

When regeneration is required, special forestry logic allows the operator to initiate a manual regeneration at a time and location of his choosing.

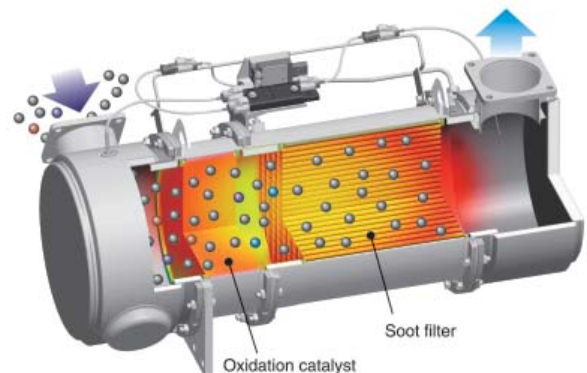

Komatsu Variable Geometry Turbocharger (KVG T)

Using Komatsu proprietary technology, a newly designed variable geometry turbocharger with a hydraulic actuator is used to manage and deliver optimum air flow to the combustion chamber under all speed and load conditions. The robust hydraulic actuator provides power and precision, resulting in cleaner exhaust gas and improved fuel economy while maintaining performance.

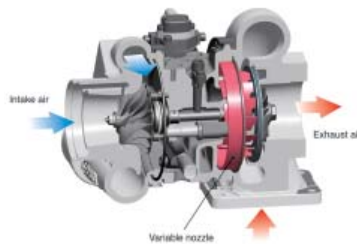

Komatsu Closed Crankcase Ventilation (KCCV)

Crankcase emissions (blow-by gas) are passed through a Komatsu CCV filter. The KCCV filter traps oil mist which is returned back to the crankcase while the gas, which is almost oil mist free, is fed back to the air intake.



Redesigned Combustion Chamber

The combustion chamber has a new shape designed to improve combustion and further reduce NOx, PM, fuel consumption, and noise levels.

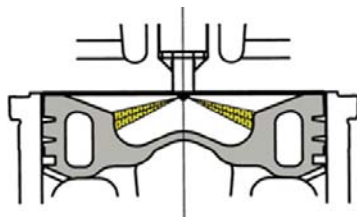

Cooled Exhaust Gas Recirculation (EGR)

Cooled EGR, a technology that has been well proven in Komatsu Tier 3 engines, reduces NOx emissions to meet Tier 4 levels. The hydraulically actuated EGR system has increased capacity and uses larger and more robust components to ensure reliability for demanding work conditions.

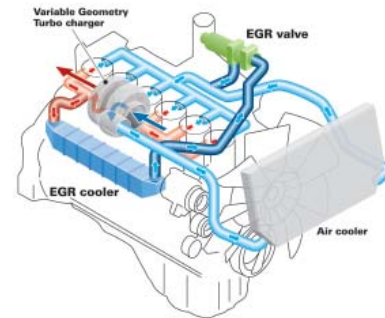

Heavy Duty High Pressure Common Rail (HPCR) Fuel Injection System

The heavy duty HPCR system is electronically controlled to deliver a precise quantity of pressurized fuel into the combustion chamber using multiple injection events to achieve complete fuel burn and reduce exhaust gas emissions. Fuel injector reliability has been improved by using ultra-hard wear resistant materials.

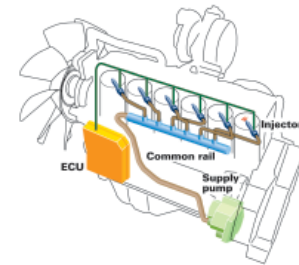

Large Digging Force - Road Builder

The PC240LL-10 is equipped with the Power Max system. This function temporarily increases digging force for 8.5 seconds of operation.

Maximum arm crowd force (ISO):

121 kN (12.3 t) ➔ **129 kN (13.2 t)** **7 % UP**
(with Power Max.)

Maximum bucket digging force (ISO):

159 kN (16.2 t) ➔ **172 kN (17.5 t)** **8 % UP**
(with Power Max.)

* Measured with Power Max function, 3045 mm arm and ISO rating

Efficient Hydraulic System

The PC240LL-10 uses a Closed Center Load Sensing (CLSS) hydraulic system that improves fuel efficiency and provides quick response to the operator's demands.

The PC240LL-10 also introduces new technology to enhance the engine and hydraulic pump control. This total control system matches the engine and hydraulics at the most efficient point under any load condition. There have also been improvements in the main valve and hydraulic circuit to reduce hydraulic loss, resulting in higher efficiency and lower fuel consumption.

Reduced Up To 10% Fuel consumption

vs PC220L-8
Based on typical work pattern collected via KOMTRAX

Large Undercarriage Design

The PC240LL-10 uses a large high and wide undercarriage design that increases overside lift capacity and improves lateral stability, especially for applications that require long reach or heavy attachments.

Large Maximum Drawbar Pull

Provides excellent maneuverability and shovel logging performance

Maximum Drawbar Pull 250.2 kN, 25511kgf, 56,244 lb

Large Displacement High Efficiency Pump

Pump displacement has been increased, providing increased flow output as well as operation at the most efficient engine speed.

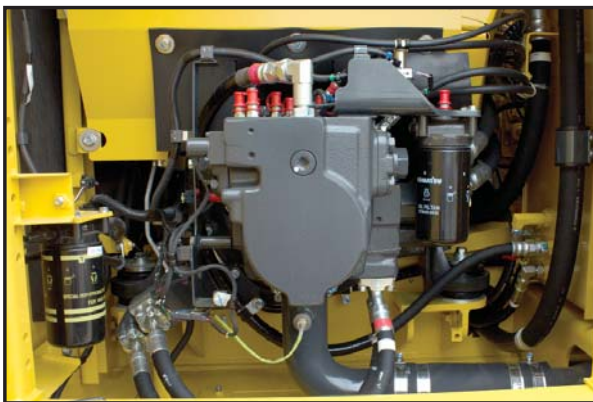

Working Mode Selection

The PC240LL-10 excavator is equipped with six working modes (P, E, L, B, ATT/P and ATT/E). Each mode is designed to match engine speed, pump flow, and system pressure to the application. The PC240LL-10 features a new mode (ATT/E) which allows operators to run attachments while in Economy mode.

Working Mode	Application	Advantage
P	Power mode	<ul style="list-style-type: none"> •Maximum production/power •Fast cycle times
E	Economy mode	<ul style="list-style-type: none"> •Good cycle times •Better fuel economy
L	Lifting mode	<ul style="list-style-type: none"> •Increases hydraulic pressure
B	Breaker mode	<ul style="list-style-type: none"> •Optimum engine rpm, hydraulic flow
ATT/P	Attachment Power mode	<ul style="list-style-type: none"> •Optimum engine rpm, hydraulic flow, 2-way •Power mode
ATT/E	Attachment Economy mode	<ul style="list-style-type: none"> •Optimum engine rpm, hydraulic flow, 2-way •Economy mode

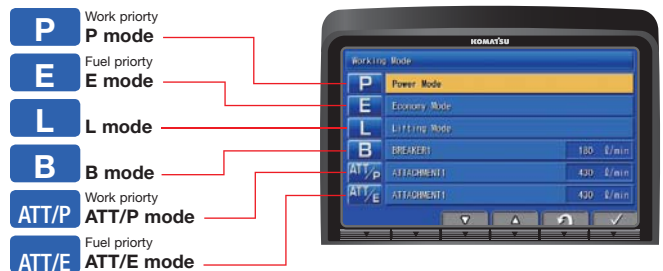

Lifting Mode

When the lifting mode is selected, the lift capacity is increased 7% by raising the hydraulic pressure.

Eco-Gauge Assists with Energy Saving Operations

The Eco-gauge and new fuel consumption gauge are viewed on the right side of the color monitor and assist the operator in maintaining lower fuel consumption and more environment friendly operation.

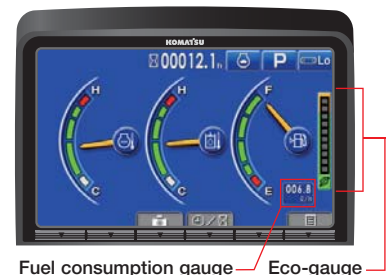

Fuel consumption gauge Eco-gauge

RELIABILITY FEATURES

High Rigidity Work Equipment

Booms and arms are constructed with thick plates of high tensile strength steel. In addition, these structures are designed with large cross-sectional areas and large one piece castings in the boom foot, the boom tip, and the arm tip. The result is work equipment that exhibits long term durability and high resistance to bending and torsional stress.



High Efficiency Fuel Filter with a Fuel Pre-filter (with Water Separator)

A new high efficiency dual element fuel filter improves fuel system reliability. A fuel pre-filter removes water and contaminants in the fuel to increase reliability. For convenience, the fuel pre-filter has a built in priming pump.

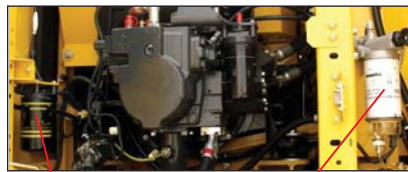

Fuel filter

Fuel pre-filter (with water separator)

Durable Frame Structure

The revolving frame, center frame, and undercarriage are designed using the most advanced three dimensional CAD and FEM analysis technology.

Highly Reliable Electronic Devices

Exclusively designed electronic devices have passed severe testing.

- Controllers
- Sensors
- Connectors
- Heat Resistant Wiring

Protective Forest Debris Screens

Engine hood, side access door and exhaust outlet cover screens provide added engine protection.



DT-type Connectors

Sealed DT-type connectors provide high reliability, water resistance, and dust resistance

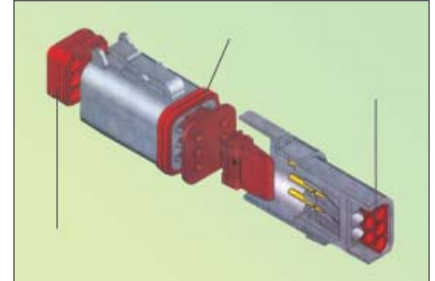

Grease Sealed Track

The PC240LL-10 uses grease sealed tracks for extended undercarriage life.

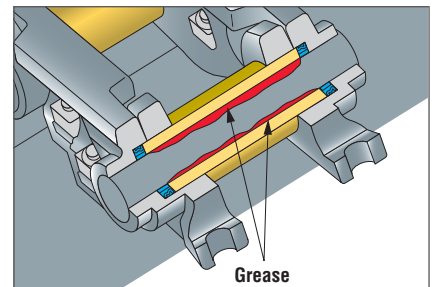

Grease

Metal Guard Rings

The PC240LL-10 uses metal guard rings to protect all of the hydraulic cylinders and improve long term reliability.

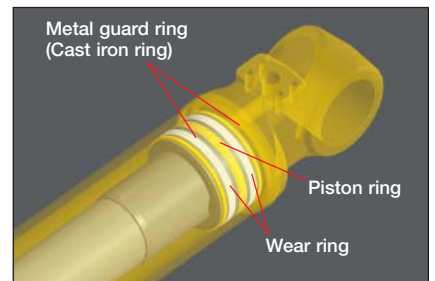

Metal guard ring (Cast iron ring)

Piston ring

Wear ring

O-Ring Face Seals

Flat face-to-face O-ring seals are used to securely seal hydraulic hose connections.



Robust Forestry Undercarriage

The undercarriage is designed using larger size class components for improved reliability and long component life.



WORKING ENVIRONMENT

KOMATSU FORESTRY CAB FEATURES & BENEFITS



New Komatsu Oregon OSHA/ROPS/OPS/ FOPS/TOPS/WCB Certified Forestry Cab

The newly designed wide spacious cab features a high back, fully adjustable seat with a reclining backrest. The console and seat have an integrated design so that they move together and provide additional comfort for the operator.

The new higher capacity operator seat has been enhanced to provide more comfort.

- Heated
- Air Suspension
- Integrated Seat
- Console Mounted Arm Rests
- The cab is available with a 7" fixed riser or 48" hydraulic tilt cab riser.



Low Cab Noise

The new cab design is highly rigid and has excellent sound absorption ability. By improving noise source reduction and by using a low noise engine, hydraulic equipment, and air conditioner, this machine is able to generate low noise levels similar to that of a modern automobile.

Automatic Air Conditioner & Heater

The automatic air conditioner & heater allows the operator to easily and precisely set the cab atmosphere using the large LCD color monitor panel. The bi-level control function improves air flow and keeps the inside of the cab comfortable throughout the year.

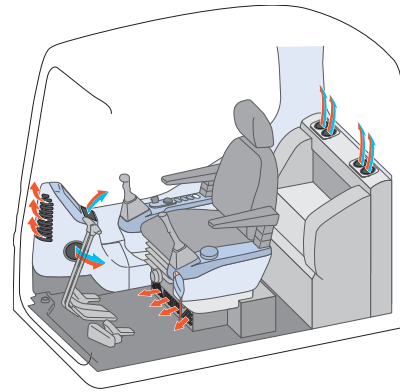

Pressurized Cab

The air conditioner, air filter, and a higher internal cab air pressure minimize the amount of external dust that enters the cab.

Low Vibration with Viscous Cab Floor Mounts

The PC240LL-10 uses viscous mounts for the seat platform that incorporate a longer stroke and the addition of a spring. The cab damper mounting combined with a high rigidity deck reduces vibration at the operator's seat.

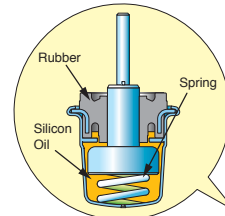

Auxiliary Input (MP3 Jack)

By connecting an auxiliary device such as an MP3 player or satellite radio receiver to the auxiliary input, the operator can hear the sound through the speakers installed in the cab.





Large 7" High Resolution LCD Monitor Panel

A new large, user-friendly, high resolution LCD color monitor enables accurate and smooth work. Screen visibility and resolution are further improved compared to the previous LCD monitor panel. The switches and function keys are easy to operate and provide simple navigation through the monitor screens.

Data is displayed in 25 languages to support operators around the world.

Indicators

- | | |
|----------------------------------|-----------------------------------|
| 1 Auto-decelerator | 5 Hydraulic oil temperature gauge |
| 2 Working mode | 6 Fuel gauge |
| 3 Travel speed | 7 Eco-gauge |
| 4 Engine water temperature gauge | 8 Fuel consumption gauge |
| | 9 Function switches menu |

Basic operation switches

- | | |
|-------------------------|---------------------|
| 1 Auto-decelerator | 4 Buzzer cancel |
| 2 Working mode selector | 5 Wiper |
| 3 Traveling selector | 6 Windshield washer |

Operational "ECO" Guidance

The monitor panel provides operational advice to the operator to help improve machine efficiency and lower fuel consumption. The operator can access the ECO guidance menu to check the Operation Records, Eco Guidance Records, and Average Fuel Consumption Logs.



ECO Guidance



ECO Guidance menu



ECO Guidance Records



Operation Records



Average Fuel Consumption Logs

Improved Attachment Control

The PC240LL-10 is capable of storing up to ten different attachments in the new monitor panel. The name of each attachment can be changed for better tool management. Hydraulic flow rates can be easily adjusted for one-way and two-way flow attachments.



Attachment Setting Screen



Attachment Flow Screen

KDPF Condition Monitor

A soot level indicator is displayed to show how much soot is trapped in the KDPF.

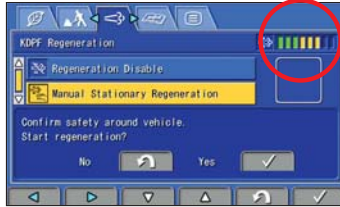

Special Forestry KDPF Regeneration

When the machine requires KDPF regeneration, a manual stationary regeneration icon appears. Manual stationary regeneration allows the operator to select a time and location of his choosing to initiate the regeneration process.



Easier Engine Access

Engine maintenance is made easier with a new platform.



Sloped Track Frame

Reduces dirt and sand accumulation while allowing easier mud removal.



Battery Disconnect Switch

A standard battery disconnect switch allows a technician to disconnect the power supply and lock out before servicing the machine.



Long Life Oils and Filters

High performance filters are used in the hydraulic circuit and engine. By increasing the oil and filter replacement intervals, maintenance costs can be significantly reduced.



Hydraulic oil filter (Eco-white element)

- Engine oil & Engine oil filter** every **500 hours**
- Hydraulic oil** every **5000 hours**
- Hydraulic oil filter** every **1000 hours**

Engine Debris Screens

Engine debris screens are easily removed and cleaned (without the need for tools).



Extended Work Equipment Greasing Intervals

Special hard material is used for the work equipment bushings to lengthen the greasing intervals. All work equipment bushing lubrication intervals, except the arm tip and bucket linkage, are 500 hours, reducing maintenance costs.

Equipment Management Monitoring System (EMMS)

The PC240LL-10 features an advanced diagnostic system that continuously monitors the machine's vital systems. EMMS tracks maintenance items, provides advanced troubleshooting tools, reduces diagnostic times, and displays error codes.

Through continuous monitoring, the EMMS helps identify issues before they become worse and allows the operator to concentrate on the work at hand.

Equipped with Eco-drain Valve

Minimizes ground contamination due to oil leakage when replacing the engine oil.



Advanced Monitoring System

The monitor provides advanced monitoring diagnostics to assist with troubleshooting and reduce costly downtime.



Maintenance Tracking

When the machine approaches or exceeds the oil and filter replacement interval, the monitor panel will display lights to inform the operator.



Abnormalities Display with Code

When an abnormality occurs an error code is displayed on the monitor. When an important code is displayed, a caution lamp blinks and a warning buzzer sounds to alert the operator to take action.



The monitor also stores a record of abnormalities for more effective troubleshooting.



Thermal Protective Covers

Thermal protective covers for variable geometry turbocharger (KVGT) and diesel particulate filter (KDPF).



Handrails

Handrails have been added on the upper structure of the machine. This provides additional convenience during engine service.



Fan Guards

Fan guards are placed around parts of the engine and fan drive.



Working Lights

Work light package includes: (4) cab front top, (2) cab rear top, (1) cab left side, (1) right hand box, and (2) the forestry arm/excavator boom, (1) front of optional 48" cab riser.



Rear-view Monitoring System (standard)

On the large LCD color monitor the operator can view the image from one camera that will display areas directly behind the machine.



Rear view image on monitor

Seat Belt Caution Indicator

A warning indicator on the monitor appears when the seat belt is not engaged.



Lock Lever

When the lock lever is placed in the lock position, all hydraulic controls (travel, swing, boom, arm, and bucket) are inoperable.



Secondary Engine Shutdown Switch

A new secondary switch has been added to shutdown the engine.



Slip Resistant Plates

Durable slip resistant plates maintain excellent foot traction.



Tilting Cab Riser

Optional 48" riser has a hydraulic cab tilt feature to reduce transport height. Operates with convenient remote control from ground level.



Compartment Covers

Rear compartment doors/covers are more than 3 times thicker than on comparably-sized excavators. Doors feature stronger hinges.

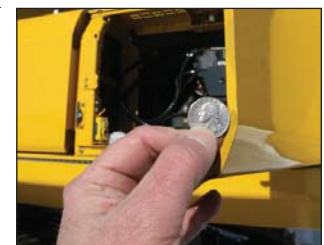

KOMTRAX EQUIPMENT WORKING ENVIRONMENT MONITORING

GET THE WHOLE STORY WITH
KOMTRAX[®]

✓ WHAT

KOMTRAX is Komatsu's remote equipment monitoring and management system

- KOMTRAX **continuously monitors and records** machine health and operational data
- Information such as fuel consumption, utilization, and a detailed history **aids in making repair or replacement decisions**

✓ WHEN

- Know when your machines are **running or idling** and make decisions that will improve your fleet utilization
- Detailed movement records ensure you know when and where your equipment is moved
- Up to date records allow you to **know when maintenance was done** and help you plan for future maintenance needs

✓ WHERE

- KOMTRAX data **can be accessed virtually anywhere** through your computer, the web or your smart phone
- Automatic alerts keep fleet managers up to date on the latest machine notifications

✓ WHY

- Knowledge is power - **make informed decisions** to manage your fleet better
- Knowing your idle time and fuel consumption will help maximize your machine efficiency
- **Take control of your equipment** - any time, anywhere

✓ WHO

- KOMTRAX is **standard** equipment on all Komatsu Log Loader Forestry products

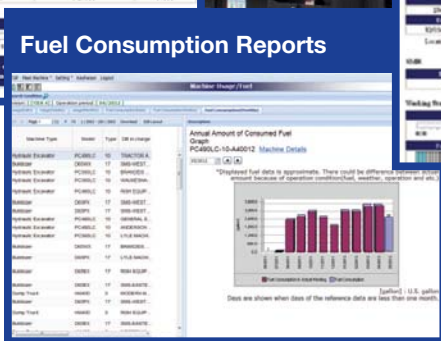
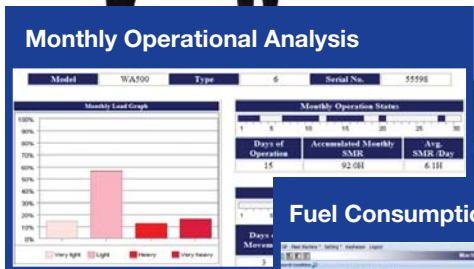

KOMTRAX[®]

For construction and compact equipment.

KOMTRAX Plus

For production and mining class machines.

KOMATSU PARTS & SERVICE SUPPORT



Komatsu CARE – Complimentary Scheduled Maintenance

- PM services for the earlier of 3 years / 2000 hours
- Performed by factory certified technicians
- Komatsu Genuine parts and fluids
- Significantly lowers your cost of ownership while maintaining high uptime and reliability
- Increases resale value and provides detailed maintenance records
- Extended PM services can be purchased beyond the complimentary period to provide additional peace of mind and maximize uptime



Komatsu Parts Support

- 24/7/365 to fulfill your parts needs
- 9 parts Distribution Centers strategically located across the U.S. and Canada
- Distributor network of more than 300 locations across U.S. and Canada to serve you
- Online part ordering through Komatsu eParts
- Remanufactured components with same-as-new warranties at a significant cost reduction

Komatsu CARE – Extended Coverage

- Extended Coverage can provide peace of mind by protecting customers from unplanned expenses that effect cash flow
- Purchasing extended coverage locks-in the cost of covered parts and labor for the coverage period and helps turn these into fixed costs



Komatsu Oil and Wear Analysis (KOWA)

- KOWA detects fuel dilution, coolant leaks, and measures wear metals
- Proactively maintain your equipment
- Maximize availability and performance
- Can identify potential problems before they lead to major repairs
- Reduce life cycle cost by extending component life

SPECIFICATIONS



ENGINE

Model..... Komatsu SAA6D107E-2*
 Type Water-cooled, 4-cycle, direct injection
 Aspiration..... Turbocharged, aftercooled, cooled EGR
 Number of cylinders..... 6
 Bore / Stroke..... 107 mm **4.21"** / 124 mm **4.88"**
 Piston displacement..... 6.69 ltr **408 in³**
 Horsepower: SAE J1995..... Gross 141 kW **189 HP**
 ISO 9249 / SAE J1349 Net 132 kW **177 HP**
 Rated rpm..... 2000
 Fan drive method for radiator cooling..... Mechanical
 Governor..... All-speed control, electronic
 *EPA Tier 4 Interim and EU stage 3B emissions certified



HYDRAULICS

Type HydrauMind (Hydraulic Mechanical Intelligence New Design) system, closed-center system with load sensing valves and pressure compensated valves
 Number of selectable working modes 6
 Main pump (type) Variable displacement piston type
 Pumps for..... Boom, arm, bucket, swing, and travel circuits
 Maximum flow 475 ltr/min **125.5 gal/min**
 Supply for control circuit..... Self-reducing valve
 Hydraulic motors:
 Travel..... 2 x axial piston motors with parking brake
 Swing 1 x axial piston motor with swing holding brake
 Relief valve setting:
 Implement circuits 37.3 MPa 380 kg/cm² **5,400 psi**
 Travel circuit 37.3 MPa 380 kg/cm² **5,400 psi**
 Swing circuit 28.9 MPa 295 kg/cm² **4,190 psi**
 Pilot circuit 3.2 MPa 33 kg/cm² **470 psi**
 Service valve 24.5 MPa 250 kg/cm² **3556 psi**

Hydraulic cylinders: (Number of cylinders – bore x stroke x rod diameter)

	Log Loader	Road Builder
Boom (2)	150 mm x 1247 mm x 110 mm 5.9" x 49.1" x 4.3"	135 mm x 1335 mm x 95 mm 5.3" x 52.6" x 3.7"
Arm (1)	185 mm x 1421 mm x 120 mm 7.3" x 55.9" x 4.7"	140 mm x 1635 mm x 100 mm 5.5" x 64.4" x 3.9"
Bucket (1)	140 mm x 1063 mm x 100 mm 5.5" x 41.9" x 3.9"	130 mm x 1020 mm x 90 mm 5.1" x 40.2" x 3.5"

Service valve maximum flow:

First valve	475 ltr 125 U.S. gal
Second valve	237.5 ltr 63 U.S. gal



DRIVES AND BRAKES

Steering control..... Two levers with pedals
 Drive method Hydrostatic
 Maximum drawbar pull 250.2 kN 25511 kg **56,244 lb**
 Gradeability..... 70%, 35°
 Maximum travel speed: High..... 5.5 km/h **3.4 mph**
 (Auto-Shift) Mid..... 4.1 km/h **2.5 mph**
 (Auto-Shift) Low 2.4 km/h **1.5 mph**
 Service brake..... Hydraulic lock
 Parking brake..... Mechanical disc brake



SWING SYSTEM

Drive method Hydrostatic
 Swing reduction Planetary gear
 Swing circle lubrication Grease-bathed
 Service brake..... Hydraulic lock
 Holding brake/Swing lock..... Mechanical disc brake
 Swing speed 8.4 rpm
 Swing torque..... 10,494 kg•m **75,903 ft lbs**



UNDERCARRIAGE

Center frame X-frame
 Track frame Box-section
 Seal of track Sealed track
 Track adjuster Hydraulic
 Number of shoes (each side) 48
 Number of carrier rollers (each side) 2
 Number of track rollers (each side) 8



COOLANT & LUBRICANT CAPACITY (REFILLING)

Fuel tank 400 ltr **105.7 U.S. gal**
 Coolant 36 ltr **9.5 U.S. gal**
 Engine..... 23.1 ltr **6.1 U.S. gal**
 Final drive, each side..... 8.5 ltr **2.2 U.S. gal**
 Swing drive 13.7 ltr **3.6 U.S. gal**
 Hydraulic tank..... 132 ltr **34.9 U.S. gal**
 Hydraulic system..... 241 ltr **63.7 U.S. gal**



OPERATING WEIGHT (APPROXIMATE)

Log Loader:

Includes: Forestry cab with 48" riser, 700 mm double grouser shoes, Komatsu 38' live heel logging boom, heavy counterweight, battery box guard, rated capacity of lubricants, coolant, full fuel tank, operator, and standard equipment.

Road Builder:

Includes: Forestry cab with 7" riser, 700mm triple grouser shoes, 5850 mm 19'2" one-piece HD boom, 3046 mm 10'0" arm, 1.2 m³ 1.57³-yd bucket, heavy counterweight, battery box guard, rated capacity of lubricants, coolant, full fuel tank; operator, and standard equipment.

Configuration	Operating Weight	Ground Pressure
Log Loader	38,095 kg 83,985 lb	0.62 kg/cm ² 8.82 psi
Road Builder	36,167 kg 79,734 lb	0.59 kg/cm ² 8.39 psi



DIMENSIONS - LOG LOADER

	Live Heel	11,582 mm	38'
A	Overall length	14,080 mm	46'2"
B	Length on ground (transport)	13,718 mm	45'
C	Overall height (to top of boom)*	2,868 mm	9'5"
D	Overall width	3,684 mm	12'1"
E1	Overall height (to top of cab upright)*	4,955 mm	16'3"
E2	Overall height (to top of cab tilted)*	3,402 mm	11'2"
F	Overall height (to top of handrail)*	3,467 mm	11'4"
G	Ground clearance, counterweight	1,365 mm	4'6"
H	Ground clearance, minimum	716 mm	2'4"
I	Tail swing radius	2,936 mm	9'8"
J	Track length on ground	4,014 mm	13'2"
K	Track length	5,001 mm	16'5"
L	Track gauge	2,921 mm	9'7"
M	Width of crawler	3,684 mm	12'1"
N	Shoe width	700 mm	2'4"
O	Grouser height	54 mm	2.1"
P	Engine hood height	3,176 mm	10'5"
Q	Machine cab width **	3,315 mm	10'11"
R	Distance, swing center to rear end	2,906 mm	9'6"

* : Including grouser height

** : Including handrail

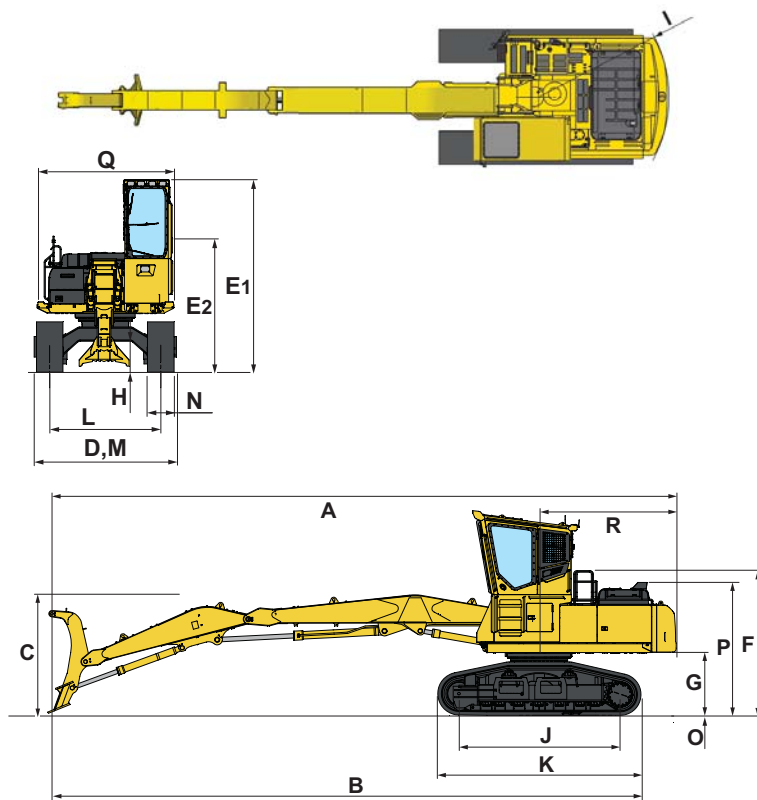

DIMENSIONS - ROAD BUILDER

	Arm Length	3045 mm	10'0"	3500mm	11'6"
A	Overall length	9777 mm	32'1"	9777 mm	32'1"
B	Length on ground (transport)	5,336 mm	17'6"	5515 mm	18'1"
C	Overall height (to top of boom)*	3,288 mm	10'9"	3690 mm	12'1"
D	Overall width	3,684 mm	12'1"		
E	Overall height (to top of cab)*	3,944 mm	12'11"		
F	Overall height (to top of handrail)*	3463 mm	11'4"		
G	Ground clearance, counterweight	1,360.8 mm	4'6"		
H	Ground clearance, minimum	712 mm	2'4"		
I	Tail swing radius	2,936 mm	9'8"		
J	Track length on ground	4,014 mm	13'2"		
K	Track length	4,961 mm	16'3"		
L	Track gauge	2,921 mm	9'7"		
M	Width of crawler	6,384 mm	12'1"		
N	Shoe width	700 mm	2'4"		
O	Grouser height	36 mm	1.5"		
P	Engine hood height	3,172 mm	10'5"		
Q	Machine cab width **	3,315 mm	10'11"		
R	Distance, swing center to rear end	2,906 mm	9'6"		

* : Including grouser height

** : Including handrail

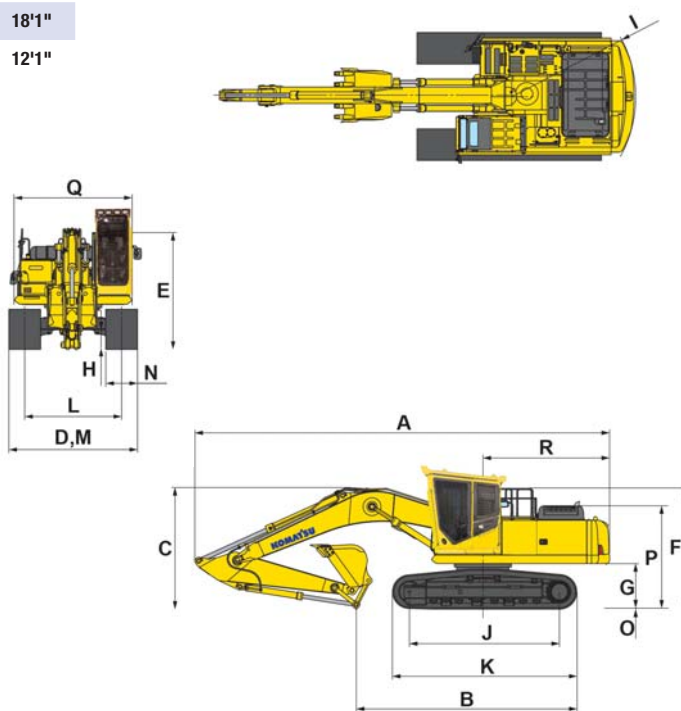



LOG LOADER WORKING RANGE

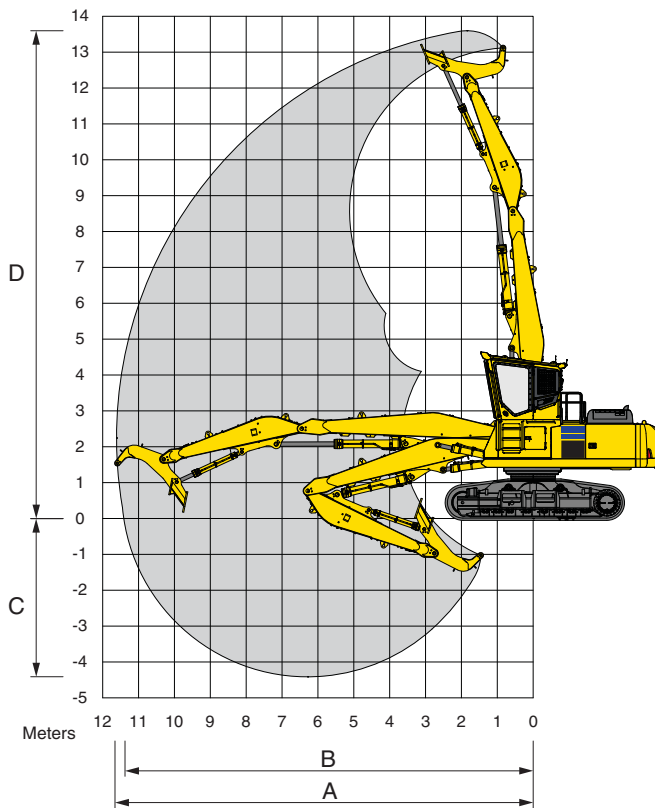

	Live Heel	11,582 mm	38'
A	Max reach	11,614 mm	38'1"
B	Max reach at ground level	11,412 mm	37'5"
C	Max below grade depth	4,362 mm	14'4"
D	Max above grade height	13,650 mm	44'9"



ROAD BUILDER WORKING RANGE

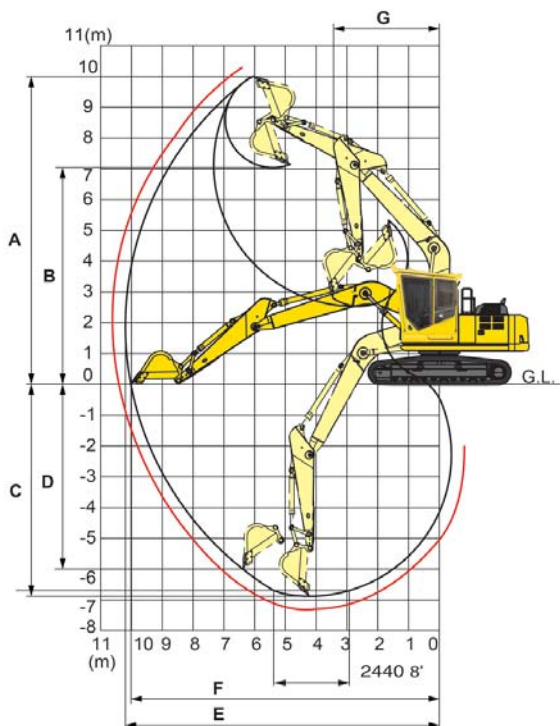

	Arm Length	3045 mm	10'0"	3500mm	11'6"
A	Max. digging height	10,512 mm	34' 6"	10645 mm	34'11"
B	Max. dumping height	7,535 mm	24' 9"	7695 mm	25'3"
C	Max. digging depth	6,528 mm	21'5"	6983 mm	22'11"
D	Max. vertical wall digging depth	5,664 mm	18'7"	5,893 mm	19'4"
E	Max. digging reach	10,196 mm	33'5"	10586 mm	34'9"
F	Max. digging reach at ground level	9,942 mm	32'7"	10342 mm	33'11"
G	Min. swing radius	3,450 mm	11'4"	3,340 mm	10'11"
SAE rating	Bucket digging force at power max.	152 kN	34,170 lb	152 kN	34,170 lb
	Arm crowd force at power max.	119 kN	26,680 lb	107 kN	24,030 lb
ISO rating	Bucket digging force at power max.	172 kN	38,580 lb	172kN	38,580 lb
	Arm crowd force at power max.	129 kN	29,100 lb	110 kN	24,690 lb

LIFT CAPACITIES

PC240LL-10



LIFTING CAPACITY WITH LIFTING MODE - LOG LOADER

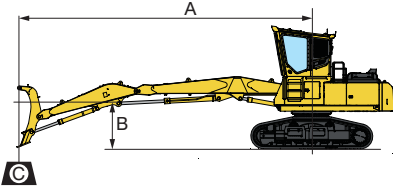

- A: Reach from swing center
- B: Bucket hook height
- C: Lifting capacity
- Cf: Rating over front
- Cs: Rating over side
- ⊗: Rating at maximum reach

- Conditions :
- Boom: Komatsu 38' Live Heel
 - Grapple: None
 - Lifting mode: On
 - Counterweight: Heavy
 - Cab: Komatsu forestry with 48" riser

Arm: Komatsu 38' Live Heel

Shoes: 700 mm 28" - Double Grouser

Unit: kg lb

B	4.6 m 15'		6.11 m 20'		7.61 m 25'		9.11 m 30'		10.71 m 35'		MAX Reach	⊗ MAX	
	Cf	Cs	Cf	Cs	Cf	Cs	Cf	Cs	Cf	Cs		Cf	Cs
12.2 m 40'	12,200 * 27,000	12,200 * 27,000									5.9 19'	10,950 * 24,150	10,950 * 24,150
10.7 m 35'			9,550 * 21,100	9,550 * 21,100	9,050 * 20,000	7,950 * 17,600					7.9 26'	8,600 * 18,950	7,400 * 16,300
9.1 m 30'			9,050 * 19,950	9,050 * 19,950	8,450 * 18,650	8,200 * 18,150	7,950 * 17,550	5,950 * 13,150			9.3 31'	7,550 * 16,700	5,750 * 12,700
7.6 m 25'			9,100 * 20,100	9,100 * 20,100	8,400 * 18,550	8,250 * 18,250	7,800 * 17,200	6,100 * 13,450			10.3 34'	6,550 * 14,500	4,900 * 10,850
6.1 m 20'			9,700 * 21,400	9,700 * 21,400	8,700 * 19,200	8,150 * 18,050	7,850 * 17,350	6,050 * 13,400	6,200 * 13,700	4,650 * 10,250	10.9 36'	5,950 * 13,100	4,440 * 9,750
4.6 m 15'	11,500 * 25,400	11,500 * 25,400	10,700 * 23,650	10,700 * 23,650	9,200 * 20,350	8,000 * 17,650	7,950 * 17,600	6,000 * 13,200	6,200 * 13,700	4,650 * 10,250	11.4 37'	5,550 * 12,300	4,150 * 9,150
3.0 m 10'	15,400 * 34,000	15,400 * 34,000	11,900 * 26,300	11,900 * 26,300	10,900 * 24,050	9,800 * 21,650	9,800 * 21,650	7,850 * 17,100	5,850 * 12,900	6,150 * 13,600	11.6 38'	4,600 * 11,900	4,000 * 8,850
1.5 m 5'	17,450 * 38,500	16,200 * 35,700	12,900 * 28,450	10,400 * 23,000	10,100 * 22,350	7,500 * 16,550	7,700 * 16,950	5,700 * 12,600	6,100 * 13,450	4,500 * 10,000	11.6 38'	5,400 * 11,900	4,000 * 8,800
0 m 0'	17,850 * 39,350	15,450 * 34,150	13,200 * 29,150	10,050 * 22,150	7,300 * 16,100	9,900 * 21,850	9,900 * 21,850	5,600 * 12,350	6,050 * 13,350	4,450 * 9,900	11.4 37'	5,050 * 11,200	4,100 * 9,050
-1.5 m -5'	15,750 * 34,800	15,150 * 33,400	12,650 * 27,900	9,800 * 21,700	9,750 * 21,500	7,150 * 15,800	7,500 * 16,550	5,550 * 12,200	5,250 * 11,650	4,450 * 9,900	11.0 36'	4,350 * 9,650	4,350 * 9,550
-3 m -10'	14,400 * 31,750	14,400 * 31,750	11,000 * 24,300	9,750 * 21,550	8,450 * 18,700	7,100 * 15,700	6,150 * 13,600	5,550 * 12,250					

*Load is limited by hydraulic capacity rather than tipping. Ratings are based on ISO standard No. 10567. Rated loads do not exceed 87% of hydraulic lift capacity or 75% of tipping load.



LIFTING CAPACITY WITH LIFTING MODE - ROAD BUILDER (WITH BUCKET)

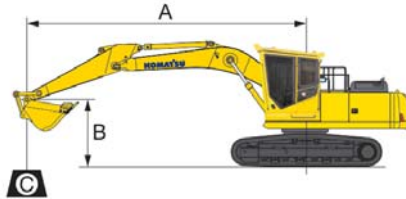

- A: Reach from swing center
- B: Bucket hook height
- C: Lifting capacity
- Cf: Rating over front
- Cs: Rating over side
- ⊗: Rating at maximum reach

- Conditions :
- Boom: 19'2" 5850 mm one piece
 - Bucket: 1.2 m³, 1.57 yd³
 - Lifting mode: On
 - Counterweight: Heavy
 - Cab: Komatsu forestry with 7" riser

Arm: 3045 mm 10'0"

Shoes: 700 mm 28" - Double Grouser

Unit: kg lb

B	1.5 m 5'		3.01 m 10'		4.61 m 15'		6.11 m 20'		7.61 m 25'		Max Reach	⊗ MAX	
	Cf	Cs	Cf	Cs	Cf	Cs	Cf	Cs	Cf	Cs		Cf	Cs
7.6 m 25'							4,850 * 10,750	4,850 * 10,750			7.0 23'	3,350 * 7,400	3,350 * 7,400
6.1 m 20'							5,150 * 11,350	5,150 * 11,350	4,750 * 10,500	4,750 * 10,500	8.0 26'	3,250 * 7,150	3,250 * 7,150
4.6 m 15'					7,050 * 15,600	7,050 * 15,600	6,150 * 13,600	6,150 * 13,600	5,750 * 12,700	5,750 * 12,700	8.6 28'	3,300 * 7,250	3,300 * 7,250
3.0 m 10'					10,100 * 22,350	10,100 * 22,350	7,550 * 16,700	7,550 * 16,700	6,450 * 14,300	6,450 * 14,300	8.8 29'	3,500 * 7,700	3,500 * 7,700
1.5 m 5'					12,750 * 28,100	12,750 * 28,100	8,950 * 19,800	8,950 * 19,800	7,250 * 15,950	7,150 * 15,850	8.9 29'	3,850 * 8,500	3,850 * 8,500
0 m 0'			6,500 * 14,500	6,500 * 14,500	14,000 * 30,900	14,000 * 30,900	9,950 * 21,950	9,750 * 21,550	7,800 * 17,250	7,050 * 15,600	8.6 28'	4,450 * 9,850	4,450 * 9,850
-1.5 m -5'	6,900 * 15,250	6,900 * 15,250	12,650 * 27,850	12,650 * 27,850	14,200 * 31,350	14,200 * 31,350	10,300 * 22,800	9,650 * 21,300	8,050 * 17,750	7,000 * 15,600	8.0 26'	5,550 * 12,300	5,550 * 12,300
-3.0 m -10'	12,100 * 26,650	12,100 * 26,650	19,000 * 41,950	19,000 * 41,950	13,750 * 30,300	13,750 * 30,300	10,050 * 22,200	9,700 * 21,400			7.1 23'	7,850 * 17,400	7,800 * 17,200
-4.6 m -15'			17,150 * 37,850	17,150 * 37,850	11,900 * 26,450	11,900 * 26,450	9,700 * 21,450				5.6 18'	9,100 * 20,150	9,100 * 20,150

*Load is limited by hydraulic capacity rather than tipping. Ratings are based on SAE standard No. J1097. Rated loads do not exceed 87% of hydraulic lift capacity or 75% of tipping load.



LIFTING CAPACITY WITH LIFTING MODE - ROAD BUILDER (WITHOUT BUCKET)

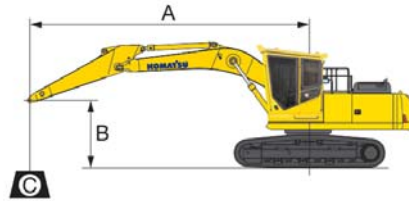

- A: Reach from swing center
- B: Bucket hook height
- C: Lifting capacity
- Cf: Rating over front
- Cs: Rating over side
- ⊗: Rating at maximum reach

- Conditions :
- Boom: 19'2" 5850 mm one piece
 - Bucket: None
 - Lifting mode: On
 - Counterweight: Heavy
 - Cab: Komatsu forestry with 7" riser

Arm: 3045 mm 10'0"

Shoes: 700 mm 28" - Double Grouser

Unit: kg lb

B	A		3.01 m 10'		4.61 m 15'		6.11 m 20'		7.61 m 25'		Max Reach	MAX	
	1.5 m 5'	3.01 m 10'	Cf	Cs	Cf	Cs	Cf	Cs	Cf	Cs		Cf	Cs
7.6 m							6,250	6,250			6.7	4,600	4,600
25'							* 13,850	* 13,850			22'	* 10,200	* 10,200
6.1 m							6,500	6,500	5,000	5,000	7.7	4,450	4,450
20'							* 14,400	* 14,400	* 11,100	* 11,100	25'	* 9,800	* 9,800
4.6 m					8,550	8,550	7,450	7,450	7,000	7,000	8.3	4,450	4,450
15'					* 18,900	* 18,900	* 16,500	* 16,500	* 15,500	* 15,500	27'	* 9,850	* 9,850
3.0 m					11,300	11,300	8,750	8,750	7,650	7,650	8.6	4,650	4,650
10'					* 24,900	* 24,900	* 19,350	* 19,350	* 16,850	* 16,850	28'	* 10,250	* 10,250
1.5 m					13,650	13,650	10,050	10,050	8,300	7,850	8.6	5,000	5,000
5'					* 30,100	* 30,100	* 22,150	* 22,150	* 18,350	* 17,400	28'	* 11,050	11,050
0 m			8,850	8,850	14,900	14,900	10,900	10,450	8,800	7,800	8.3	5,650	5,650
0'	*	*	* 19,500	* 19,500	* 32,850	* 32,850	* 24,100	* 23,100	* 19,450	17,150	27'	* 12,450	12,450
-1.5 m	9,350	9,350	14,150	14,150	15,100	15,100	11,200	10,400	8,850	7,750	7.8	6,800	6,800
-5'	* 20,650	* 20,650	* 31,250	* 31,250	* 33,300	* 33,300	* 24,750	* 22,950	* 19,500	* 17,150	25'	* 15,050	* 15,050
-3.0 m	14,750	14,750	20,400	20,400	14,300	14,300	10,650	10,450			6.8	9,250	9,050
-10'	* 32,550	* 32,550	* 45,000	* 45,000	* 31,500	* 31,500	* 23,500	* 23,100			22'	* 20,450	* 20,000
-4.6 m			16,650	16,650	11,800	11,800					5.2	9,950	9,950
-15'			* 36,750	* 36,750	* 26,050	* 26,050					17'	* 22,000	* 22,000

*Load is limited by hydraulic capacity rather than tipping. Ratings are based on ISO standard No. 10567. Rated loads do not exceed 87% of hydraulic lift capacity or 75% of tipping load.



LIFTING CAPACITY WITH LIFTING MODE - ROAD BUILDER (WITHOUT BUCKET)

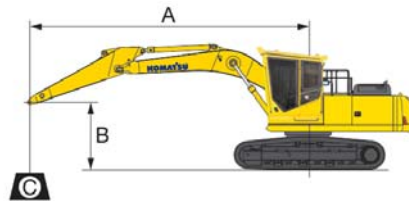

- A: Reach from swing center
- B: Bucket hook height
- C: Lifting capacity
- Cf: Rating over front
- Cs: Rating over side
- ⊗: Rating at maximum reach

- Conditions :
- Boom: 19'2" 5850 mm one piece
 - Bucket: None
 - Lifting mode: On
 - Counterweight: Heavy
 - Cab: Komatsu forestry with 7" riser

Arm: 3500 mm 11'6"

Shoes: 700 mm 28" - Double Grouser

Unit: kg lb

B	A		3.01 m 10'		4.61 m 15'		6.11 m 20'		7.61 m 25'		Max Reach	MAX	
	1.5 m 5'	3.01 m 10'	Cf	Cs	Cf	Cs	Cf	Cs	Cf	Cs		Cf	Cs
7.6 m							5,500	5,500			7.2	4,000	4,000
25'							* 12,150	* 12,150			24'	* 8,800	* 8,800
6.1 m							5,850	5,850	5,550	5,550	8.2	3,850	3,850
20'							* 12,900	* 12,900	* 12,250	* 12,250	27'	* 8,500	* 8,500
4.6 m					7,550	7,550	6,800	6,800	6,450	6,450	8.7	3,850	3,850
15'					* 16,650	* 16,650	* 15,000	* 15,000	* 14,250	* 14,250	29'	* 8,550	* 8,550
3.0 m			16,300	16,300	10,250	10,250	8,100	8,100	7,150	7,150	9.0	4,000	4,000
10'			* 36,000	* 36,000	* 22,600	* 22,600	* 17,950	* 17,950	* 15,750	* 15,750	30'	* 8,900	* 8,900
1.5 m			7,500	7,500	12,750	12,750	9,450	9,450	7,900	7,800	9.0	4,300	4,300
5'			* 16,550	* 16,550	* 28,150	* 28,150	* 20,900	* 20,900	* 17,400	* 17,200	30'	* 9,550	9,550
0 m			9,450	9,450	14,300	14,300	10,500	10,350	8,500	7,650	8.7	4,850	4,850
0'	*	*	* 20,850	* 20,850	* 31,600	* 31,600	* 23,150	* 22,800	* 18,750	16,900	29'	* 10,700	10,700
-1.5 m	8,750	8,750	13,500	12,650	14,850	14,850	11,000	10,200	8,750	7,600	8.2	5,750	5,750
-5'	* 19,300	* 19,300	* 29,750	* 29,750	* 32,750	* 32,750	* 24,250	* 22,550	* 19,300	* 16,800	27'	* 12,700	* 12,700
-3.0 m	13,150	13,150	19,450	19,450	14,400	14,400	10,750	10,250			7.3	7,600	7,600
-10'	* 29,050	* 29,050	* 42,900	* 42,900	* 31,750	* 31,750	* 23,700	* 22,600			24'	* 16,800	* 16,800
-4.6 m			17,900	17,900	12,600	12,600					5.9	9,450	9,450
-15'			* 39,500	* 39,500	* 27,850	* 27,850					19'	* 20,850	* 20,850

*Load is limited by hydraulic capacity rather than tipping. Ratings are based on ISO standard No. 10567. Rated loads do not exceed 87% of hydraulic lift capacity or 75% of tipping load.



STANDARD EQUIPMENT

- Alternator, 60 Ampere, 24 V
- AM/FM radio
- Automatic engine warm-up system
- Automatic air conditioner/heater
- Auxiliary input (3.5mm jack)
- Batteries, large capacity
- Battery disconnect switch
- Boom and arm holding valves
- Cab: Komatsu Oregon OSHA/ROPS/OPS/ FOPS/TOPS/WCB Certified Forestry Cab
- Converter, 24 V to 12 V
- Counterweight, 4920 kg **10,847 lb**
- KDPF insulation wrap and heat shields
- Dry type air cleaner, double element
- Electric horn
- EMMS monitoring system
- Engine doors, HD (6mm)
- Engine, Komatsu SAA6D107E-2
- Engine overheat prevention system
- Extended work equipment grease interval
- Fan guard structure
- Forest debris screens, removable for cleaning
- Fuel system pre-cleaner 10 micron
- High back air suspension seat, with heat
- High and wide forestry undercarriage
- High pressure in-line hydraulic filters
- Grip strut walkways
- Hydraulic track adjusters
- KOMTRAX® Level 4.0
- Large 177mm **7"** LCD color monitor, high resolution
- Lock lever
- Mirrors, (LH and RH)
- Power maximizing system
- PPC hydraulic control system
- Pump/engine room partition cover
- Radiator and oil cooler dustproof net
- Rear reflectors
- Rearview monitoring system (1 camera)
- Revolving frame undercovers, HD (9mm)
- Seat belt, retractable, 76 mm **3"**
- Seat belt indicator
- Secondary engine shutoff switch
- Service valve
- Shoes, triple grouser, 700 mm **28"**
- Swivel guard, HD
- Skylight
- Slip resistant foot plates
- Starter motor, 5.5 kW/24 V x 1
- Suction fan
- Thermal and fan guards
- Travel alarm
- Working Lights 4 on cab front top, 2 on cab rear top, 1 on cab left side, 1 on right hand box, and 2 on the forestry arm or excavator boom (plus 1 on front of optional 48" cab riser)
- Working mode selection system



OPTIONAL EQUIPMENT

- Arm holding valve
- Arms
 - 3045 mm **10'0"** HD arm assembly
 - 3045 mm **10'0"** HD arm assembly w/piping
 - 3045 mm **10'0"** arm assembly without bucket cylinder, linkage or pins
 - 3500 mm **11'6"** standard arm assembly
 - 3500 mm **11'6"** HD arm assembly w/piping
- Booms
 - 5850 mm **19'2"** HD boom assembly
 - 5850 mm **19'2"** HD boom assembly with piping
- Boom cylinders only
- Box guard, right hand, HD
- Cab Risers
 - Forestry cab, 177mm **7"** fixed riser
 - Forestry cab, 1220mm **48"** tilting riser
 - Temporary shipping shell on "stilts"
- Counterweight 6530 kg **14,396 lb**
- Flow control and spool limiters
- Forestry grapples: 52" or 58" opening
- Live heel logging boom, 11582mm **38'**
- Shoes
 - double grouser, 700 mm **28"**
 - triple grouser, 800 mm **31.5"**
- Soft swing
- Straight travel system pedal

KOMATSU®

Note: All comparisons and claims of improved performance made herein are made with respect to the prior Komatsu model unless otherwise specifically stated.